

User Manual

Milli-Q® IQ 7003/7005/7010/7015



Table of contents

INTRODUCTION	1
System overview	2
QUICK START	5
Exit screensaver	5
Dispense ultrapure water (Q-POD)	5
Dispense pure water (E-POD)	6
Dispense report	8
View & manage Alerts and Alarms	9
Navigate the screen interface	10
CONSUMABLE MENU	12
INFORMATION MENU	14
System	14
History	14
Flow schematic	15
Troubleshooting	15
Contacts	16
SETTINGS MENU	17
Manager access & password	19
System configuration	20
Production configuration	21
POD configuration	21
Accessories	22
Alarm configuration	23
Connectivity	24
Date Time & Language	24
Units	25
MAINTENANCE MENU	26
Consumable installation wizards	27
Cleaning & Sanitization	31
Depressurization	32
ech ₂ o UV lamps - mercury free	33
SELF HELP GUIDE	34
Depressurize system	34
Turn system off	34
Inaccurate volumetric dispensing	34
High TOC values	34
Low flowrate	35
Tank is not re-filled of pure water	35
Icons	36
REQUIREMENTS AND SPECIFICATIONS	37
Water specifications	37
System specifications	41
Dimensions and weights	43
Ordering Information	47
LEGAL INFORMATION & WARRANTY	49

INTRODUCTION

Congratulations!
Thank you for buying a Milli-Q water purification system.

Milli-Q® IQ 7003/7005/7010/7015 produces ultrapure water from a tap water source. Installation of this product should be performed by a qualified service representative with access to qualified installation documentation.

This user manual is a guide for use during the normal operation and maintenance of a Milli-Q IQ 7003/7005/7010/7015 water purification system. It is highly recommended to fully read this manual and comprehend its contents before handling the water purification system.

System identification

System	Catalogue number	Voltage	Frequency
Milli-Q® IQ 7003	ZIQ7003T0	100-240 V	50-60 Hz
Milli-Q® IQ 7005	ZIQ7005T0	100-240 V	50-60 Hz
Milli-Q® IQ 7010	ZIQ7010T0	100-240 V	50-60 Hz
Milli-Q® IQ 7015	ZIQ7015T0	100-240 V	50-60 Hz

Manufacturing site:
Millipore SAS, 67120 Molsheim, France

For more information on your Milli-Q system, please call your local representative or visit our website www.emdmillipore.com (North America) or www.merckmillipore.com (Rest of the World).

Intended use

The Milli-Q IQ 7003/7005/7010/7015 is intended to produce pure (type 2) and ultrapure (type 1) water from a tap water source primarily for use in research and quality control in a variety of laboratories worldwide.

The product is designed to produce ultrapure water with specific characteristics (refer to the requirements and specifications section) when it leaves the water purification system, provided that it is fed with water quality within specifications and properly maintained as required by the supplier.

Merck KGaA does not warrant the product for any specific application. It is up to the user to determine if the quality of the water produced by the product matches their expectations, fits with norms/legal requirements and to bear responsibility resulting from the usage of the water.

The product is not intended to produce: water for injection, water for dialysis, sterile water for irrigation or injection, bacteriostatic water for injection, sterile purified water in containers, and sterile water for injection in container or ingestion. The product is not intended to be used in explosive environments according to ATEX Directive – equipment & protective systems intended for use in potentially explosive atmospheres. In addition the product is not intended as a Medical Device, including In-Vitro Devices.

System overview

Milli-Q IQ 7003/7005/7010/7015 consists of different units:

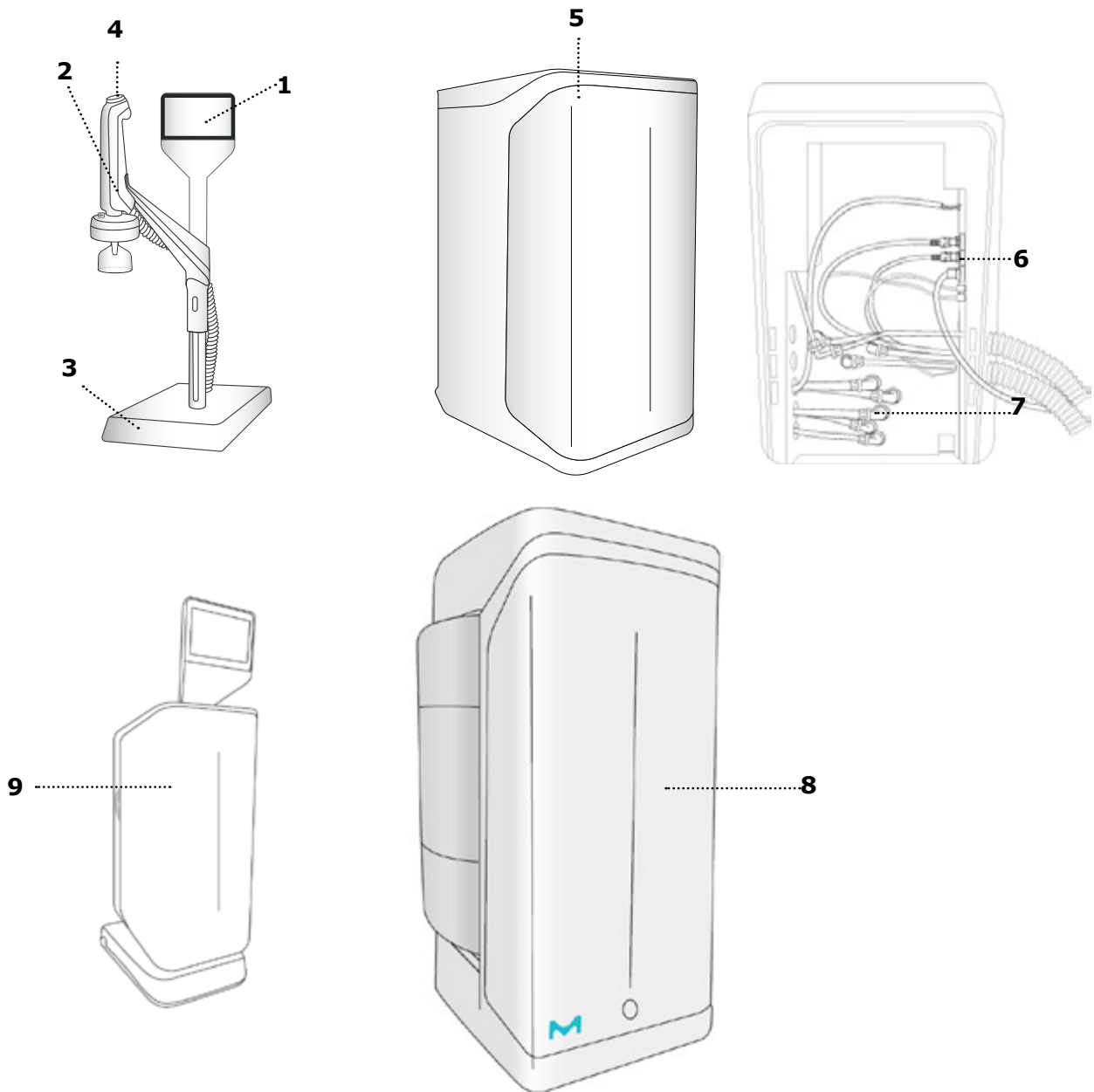

1	POD (Point of Dispense) with screen interface	6	Electrical connections
2	POD dispenser	7	Hydraulic connections
3	POD base	8	Storage tank
4	Dispensing wheel	9	Milli-Q® IQ Element (optional)
5	Water purification unit		

Description of the system

The Milli-Q® IQ 7003/7005/7010/7015 manages the production and the distribution of pure (Type 2) and ultrapure (Type 1) water from a tap water source. It is composed of three different sections:

- Water purification unit manages the production of pure and ultrapure water.
- Point of dispense (POD) integrates the screen interface and manages the dispensing of pure (E-POD®) and ultrapure (Q-POD®/Milli-Q® IQ Element) water. At least one Q-POD® is necessary and up to 4 PODs can be installed, 1 E-POD® + 3 Q-POD® or 4 Q-POD®.
- Storage tank stores and maintains the pure water quality.

System flow-schematics

The system is fed with tap water and the distribution loop is fed by a storage tank.

Production flow-schematic

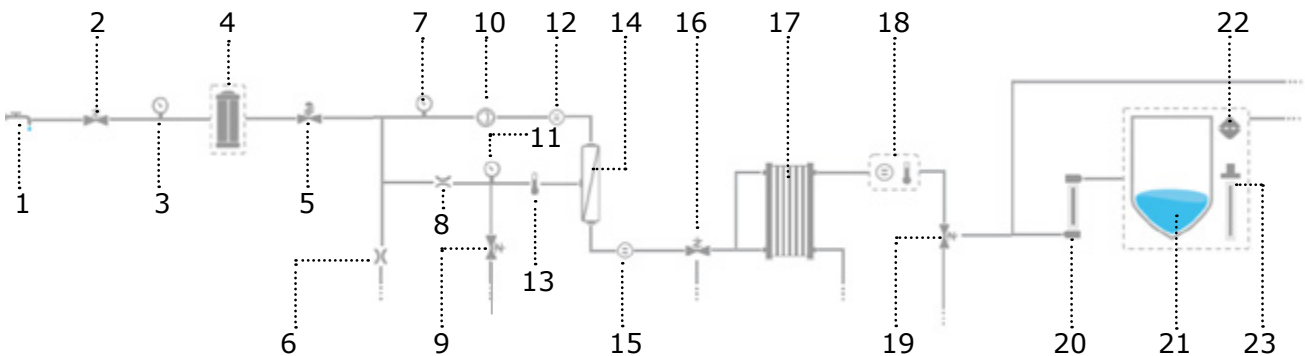

Distribution flowschematic

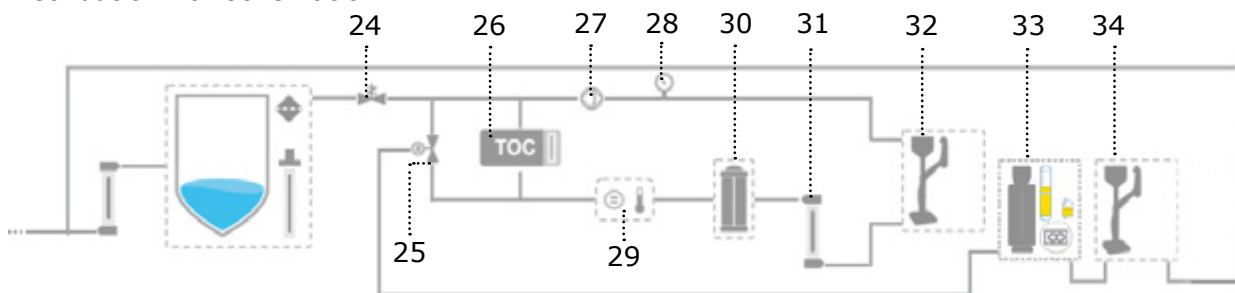

1	Tap Feed Water	18	Pure water Resistivity Cell
2	Inlet Solenoid Valve	19	Pure water 3 Ways Valve
3	System Feed Pressure Sensor	20	ech ₂ o® bactericidal lamp
4	IPAK GARD®	21	Storage Tank
5	Pressure Regulator	22	Vent Filter
6	Reverse Osmosis (RO) Reject Capillary	23	ech ₂ o® ASM lamp
7	RO Pump Feed Pressure Sensor	24	Distribution Inlet Solenoid Valve
8	Flow Controller	25	Motorized Valve
9	RO Flush Solenoid Valve	26	TOC Monitor
10	RO Pump (bypass 180psi)	27	Distribution Pump
11	RO Pressure Sensor	28	Pressure Sensor
12	Feed Conductivity Cell	29	Ultrapure Resistivity Cell
13	Thermistor	30	IPAK QUANTA®
14	RO membrane (1 or 2 depends on syst type)	31	ech ₂ o® oxidation lamp
15	Permeate Conductivity Cell	32	E-POD®
16	Permeate 3 Ways Valve	33	Milli-Q® IQ Element (optional)
17	Elix® EDI Module	34	Q-POD®

This system uses potable tap water as feed and produces pure (Type 2) and ultrapure water (Type 1) delivered by independent POD dispensers.

The system is divided into three sections. These are the production, the storage and the distribution.

Production: Tap water is first purified by the IPAK Gard® pretreatment pack which contains the pleated filter and carbon block. Particles, colloids and free chlorine are efficiently removed before the reverse osmosis purification. The intelligent reverse osmosis (RO) purification that follows controls water consumption, ensures a constant product flow rate and optimal water quality. Majority of contaminants are removed at this stage such as the ions, particles, bacteria and large organics. The purified RO water then enters the patented Elix® electrodeionization module, where ion-exchange resins are continuously regenerated by a small electrical field. The pure water then passes through the mercury-free ech₂o bactericidal lamp where bacteria is further eliminated resulting in pure water that is stored in the storage tank.

Distribution: Pure water is stored in high-quality polyethylene tank, which is equipped with the vent filter and the mercury-free ech₂o ASM lamp. The vent filter maintains the consistent purity of stored water and provides effective protection against airborne contaminants. The ech₂o ASM lamp further protects the integrity of the stored water with regular exposure to bactericidal UV light. Purified water then flows to the mercury-free ech₂o oxidation lamp. Organic molecules are partially oxidized, resulting in ions. These are then captured in the next stage when the purified water enters the IPAK Quanta polishing cartridge, composed of ion-exchange resins and synthetic activated carbon.

Throughout the purification steps, quality parameters are monitored with resistivity sensors and the A10® TOC (total oxidizable carbon) monitor. The A10 TOC Monitor uses a small UV lamp during its TOC analysis mode. This is called the ech₂o A10 TOC Lamp.

The E-POD and Q-POD are the main interfaces with the user. They are configured with 2 or 5 meter connectors to the main production unit depending on the laboratory setting. The arm holding the dispenser on the mast can be moved up and down to adapt to laboratory glassware. Its dispensing 'wheel' delivers water from precise drop-by-drop up to fast 2 L/min flowrate. The POD's large 5" touchscreen offers a wide range of applications for users. It also has an USB port to easily export data. At the outlet of the dispenser, the final purification is performed by the application-specific POD-Pak.

When not in active use, the water within the units will recirculate for three minutes every hour. This is to maintain water quality, a clean environment and to avoid contamination. The system should not be turned off as this will stop the periodic recirculation taking place.

QUICK START

Exit screensaver

If the setting is active and there has been a certain time of user inactivity, the screensaver will be displayed on the POD touch-screen.

Screensaver

Tap anywhere on the screen or initiate a manual dispense by pressing the dispenser wheel to exit the screensaver.

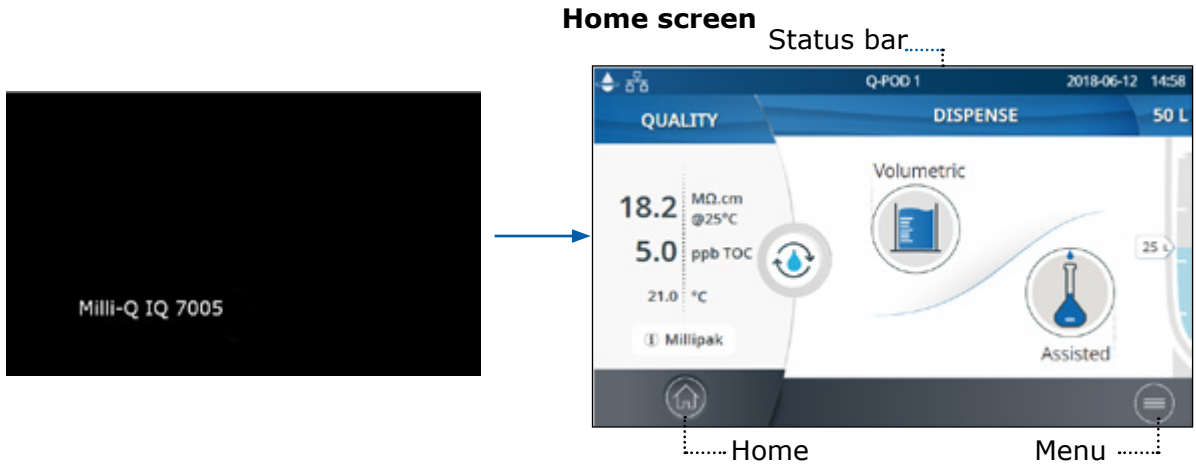

Dispense ultrapure water (Q-POD)

It is a good practice to always recirculate water before dispensing. To do this, press on the recirculation icon, this also refreshes the water quality parameters:

- Product resistivity
- TOC
- Temperature

Recirculate



There are several options to dispense ultrapure water:

Manual Dispensing

To start dispensing in drop-by-drop, turn the dispense wheel one notch counter-clockwise.

To start dispensing at full flow, press down on the wheel.

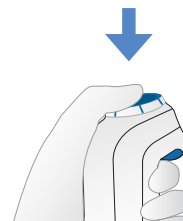

Adjust flow rate

To increase the flow rate keep turning the wheel counter-clockwise until full flow is reached. To decrease the flow rate, turn the wheel clockwise.

Stop

To stop any ongoing dispensing, press down on the wheel or rotate the wheel clockwise until no more water flows from the dispenser.

Drop-by-drop  Full flow



Dispense pure water (E-POD)

It is a good practice to always recirculate water before dispensing.

To do this, press on the recirculation icon, this also refreshes the water quality parameters:

- Elix resistivity
- Temperature

There are several options to dispense pure water:

Manual Dispensing

To start dispensing at low flow, turn the dispense wheel one notch counter-clockwise.

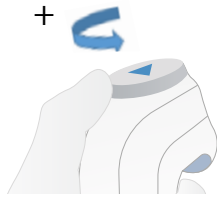

To start dispensing at full flow, press down on the wheel.

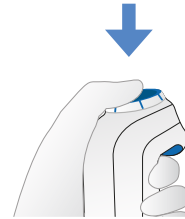

Adjust flow rate

To increase the flow rate keep turning the wheel counter-clockwise until full flow is reached. To decrease the flow rate, turn the wheel clockwise.

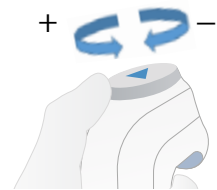

Stop

To stop any ongoing dispensing, press down on the wheel or rotate the wheel clockwise until no more water flows from the dispenser.



Volumetric Dispensing (20mL to 100L)

Enables a user to auto dispense a pre-selected volume.

Note: When connected to a storage tank, always make sure there is enough water present before dispensing. This information is always displayed on the main screen.

1- Select unit and input volume to dispense, press ok to validate.

2- Press the start icon on the screen or the dispenser wheel to initiate the dispense.

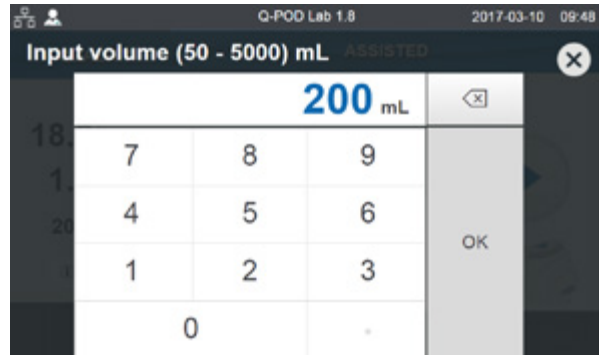
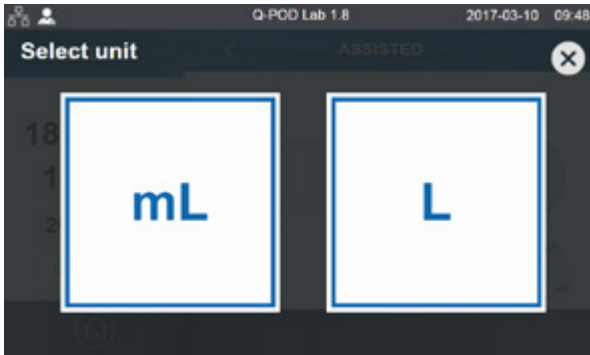

The system will automatically stop once the input volume is reached.

Note: The system keeps in memory the last volume dispensed. To repeat a volumetric dispense, click on the start icon or the dispenser wheel.



Assisted Dispensing (50mL to 5L) (Q-POD only)

Like volumetric dispensing, a pre-selected volume is auto-dispensed and the last millilitres are distributed drop-by-drop for the user to manually stop the flow when the calibration mark is reached. The assisted dispensing function brings more precision, avoiding the use of an intermediary container and possible source of contamination.

1- Select unit and input volume to dispense, press OK to validate.

2- Press the start icon on the screen or the dispenser wheel to initiate the dispense.

The system dispenses in high-flow 96% of the required volume and automatically switches to drop-by-drop to enable a user to manually and precisely reach the calibration mark of a volumetric flask.

3- User must manually stop the drop-by-drop dispensing.

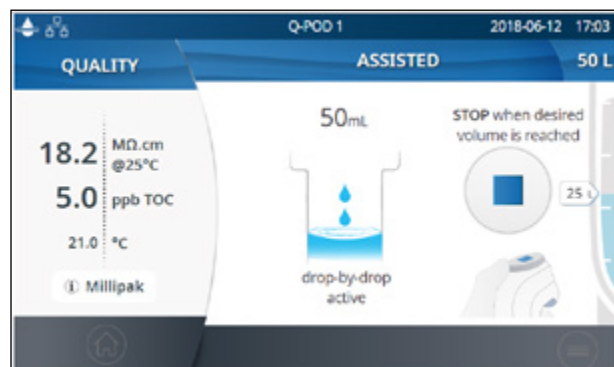

Important! The dispensing must be stopped by the user by either pressing on the dispenser wheel or the *stop dispense* icon on the touch-screen.

Dispense report

A dispense report is automatically produced after each dispensing operation. A dispensing operation is considered to be all dispenses with less than 10 second intervals between them. This can be interrupted at any time by pressing on the dispense report icon that becomes available on the home screen as soon as a dispense is initiated.

1. Visualize

Click on the dispense report icon:

Dispense
report

2. Personalize (assign a name or experiment number)

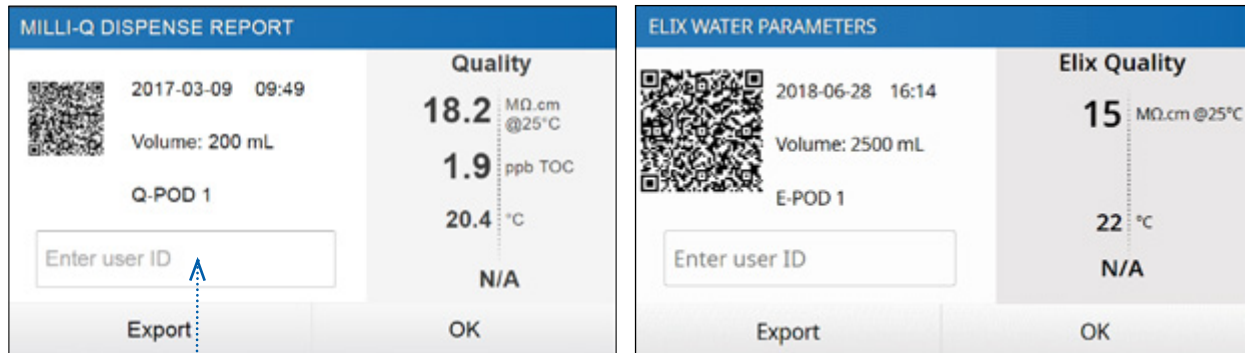

In the user ID field, enter the content of your choice (max 15 characters)

3. Export



- Scan the QR code from a mobile device to instantly retrieve the report.
- Click on the export button to save the report on a USB key.

4. Automatic archiving

The dispense report icon on the home screen will automatically disappear after 5 minutes of inactivity. Each dispense report, whether consulted or not, is automatically archived and can be retrieved anytime by going in the history report section available in the information menu. Go to page 14 [Information > History](#) for further information.

View & manage Alerts and Alarms

Alerts give you advanced warning when maintenance is required and Alarms notify you when the system has encountered a technical issue.

Press on the alert  or the alarm  icon present in the bottom bar to display the alert(s) or/and alarm(s) which are active.

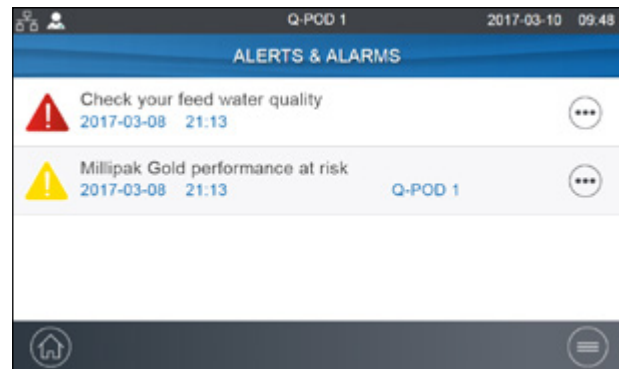

Note: The notification number indicates how many active alarms are present. When there are no active alerts or alarms, the icon disappears.

Select a specific alert or alarm to get further information and better understand the root cause. Advice is provided in the information section to help the user troubleshoot.

If the issue is not resolved, select the **Contact** tab to find the technical support hotline number for further assistance.

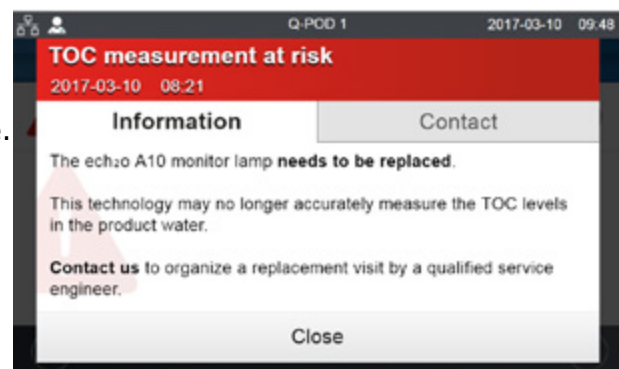

To protect the system and user applications, alarms of a serious nature will automatically stop the system from dispensing water.

Note: These are displayed on the screensaver to alert the user when the system is not in active use.

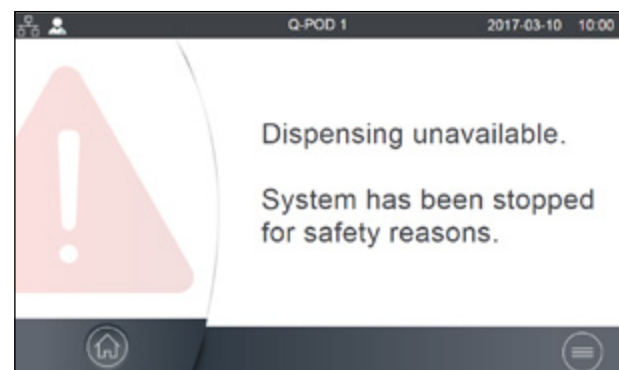

Alerts provide advanced warning of any maintenance actions that will be required. These can be "closed" to be reminded again in 24h or can be "cleared" permanently.

An **Order** tab will be present containing ordering information when applicable.

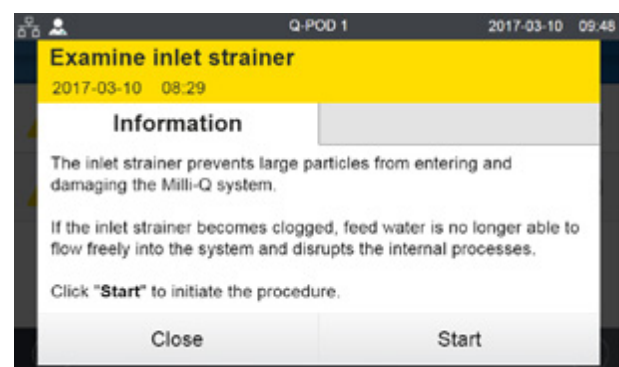

Navigate the screen interface

Each POD has a 5" touch-screen that allows a user to control and monitor the water system. All sub-menus and applications can easily be reached in a few clicks or swipes, as on a smart-phone.

HOME SCREEN



Home

- Water quality information
- Dispensing functions
- Alerts & Alarms (when applicable)
- Dispense report (when applicable)

MAIN MENUS



Menu

- Consumables
- Information
- Settings
- Maintenance
- Login

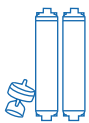

[Go to Consumables Menu](#)



[Go to Information Menu](#)



[Go to Settings Menu](#)



[Go to Maintenance Menu](#)



[Go to Manager access](#)

Apps

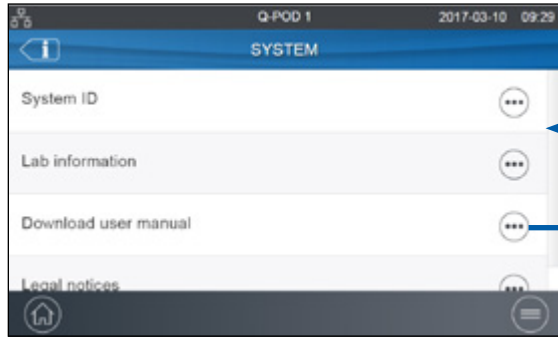
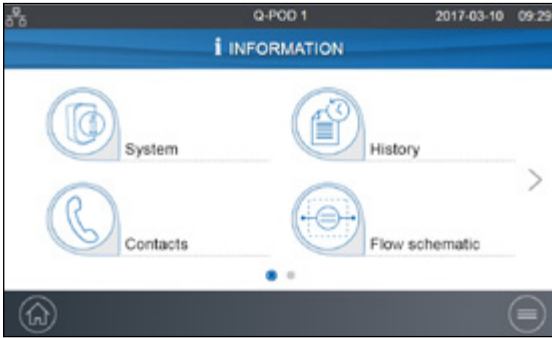

When there are multiple lines, a scroll bar is present to swipe up & down



Indicates how many screens are present and where you are.

Swipe left & right anywhere on screen to switch between screens.

Pops-up

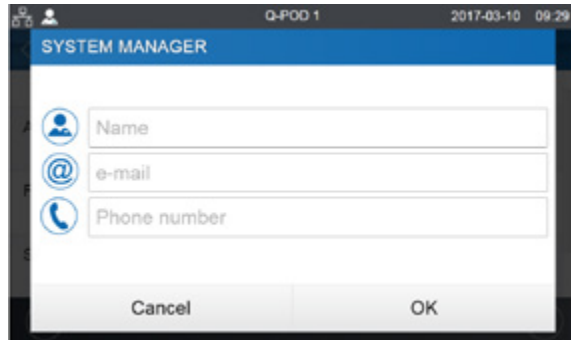
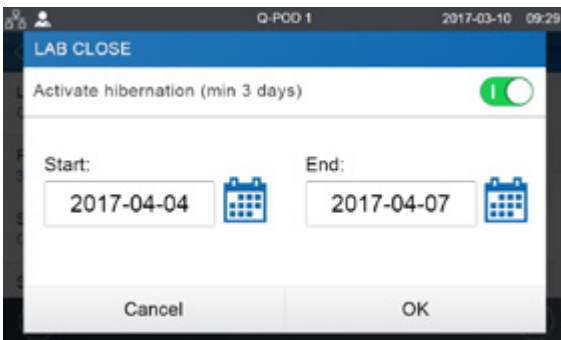

When you click in a zone of text, the keypad will automatically appear.

To remove the keypad click on  or on any zone outside the keypad.



Note: When in a menu or app level screen, 1 minute of inactivity generates a time-out back to the home screen.

When in a pop-up level screen, there is no time-out, therefore the user remains on this screen until the pop-up is manually closed.

Important! If multiple Q-PODs are installed and a pop-up in the settings or maintenance menus is not closed, dispensing will remain unavailable on all Q-PODs until the pop-up is manually closed.

CONSUMABLE MENU

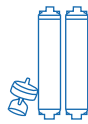

Viewing Consumables Status

Colour icons allow to instantly view the status of all installed consumables.

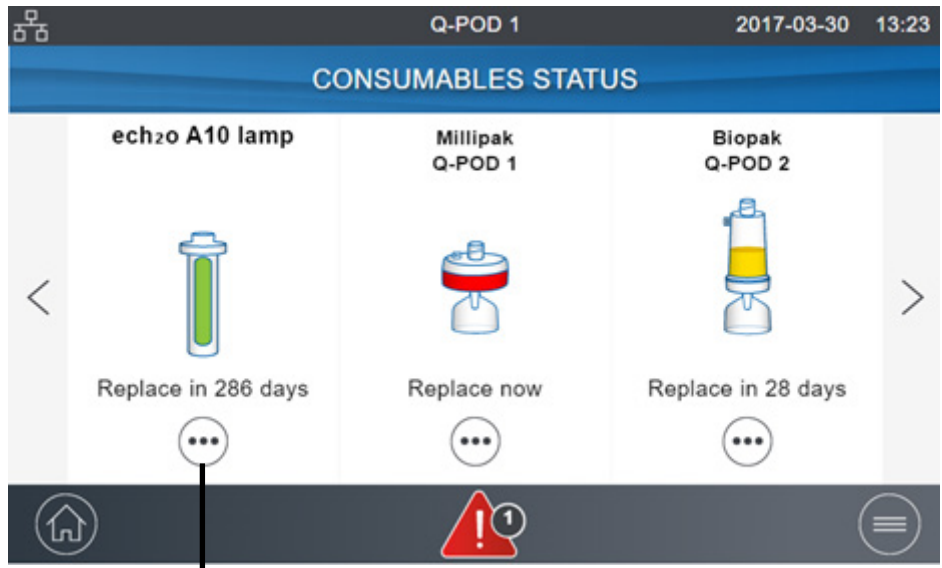

Green: no action required
Yellow: notice for a maintenance action
Red: maintenance required!

Press on the  icon to get the consumable ID, ordering information and a description of the purification technology.

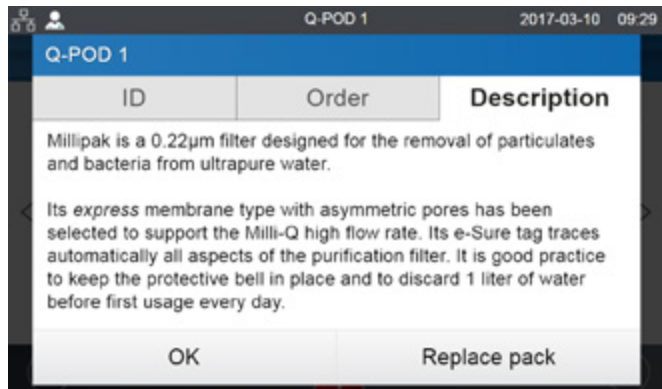

Note: Certificates of quality are now available online www.mymilliqconsumables.com

All cartridges have been designed to be easily replaced by a user. A short-cut is available to the replacement wizard by clicking on the "replace pack" button in the pop-up.

Important! ech₂o UV lamps should not be replaced by users. Contact the technical support hotline to organize a replacement visit.

ech₂o cartridge collection and recycling program

For United States users only
Go to page 46 [recycling section](#).



Consumable identification with card reading



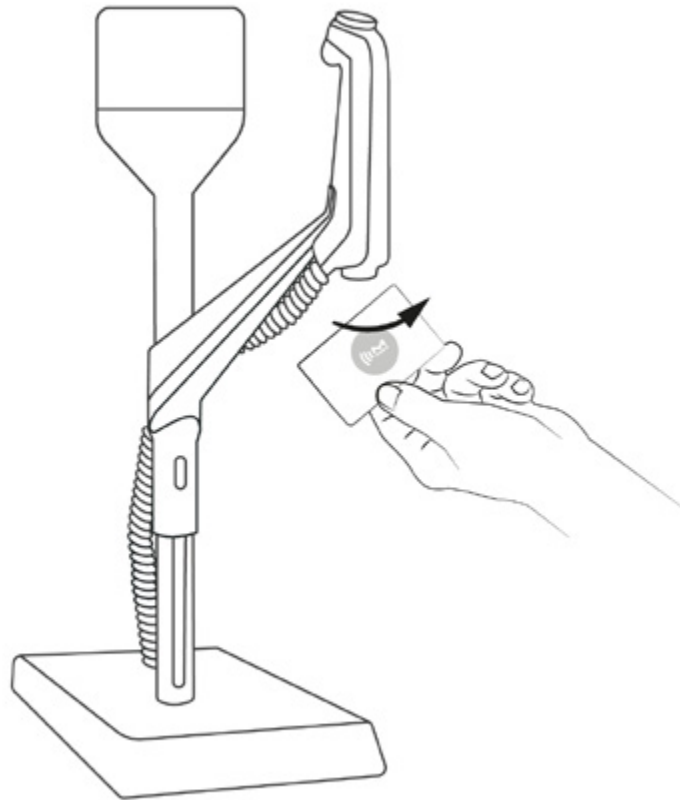

Some of the consumables come with a card for scanning and identification by the system. For system consumables, the card must be scanned on the end of the dispenser (e-Sure tag reader).



INFORMATION MENU

This menu contains useful system information and provides a system status. Dispensing is available while in this menu.

Available apps:

 System	 History	 Troubleshooting
 Contacts	 Flow schematic	

System

Find system details

Select *System ID* to find the information on the water system model and installation details.

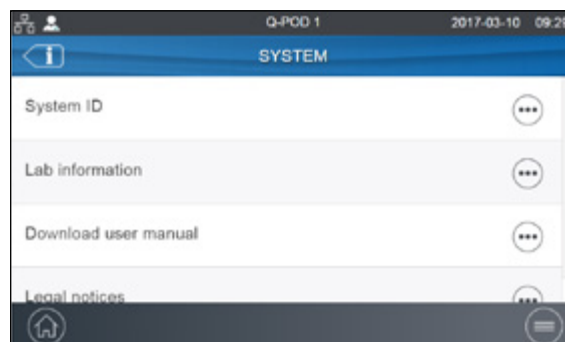

Download user manual

The user manual is available in 9 languages and it can be downloaded through a USB key or if connected to a network, to any computer device.



History

2 user reports exist:

- [Daily quality measures report](#)

Each row represents a day (24h) and is dated. It contains daily averages for product resistivity, temperature and TOC. Also included is the total volume dispensed during the day.

- [Dispensing events report](#)

Each row is a dispense operation. It is an archive of all the dispense reports.

To export data or preview a graph:

1. Select a time period of interest with a start and end date.
2. A graph pre-view of the last 30 records is available on the Q-POD screen.
3. Export the report in .ods (open document source) format to visualize the full data and integrate them into a data management system.

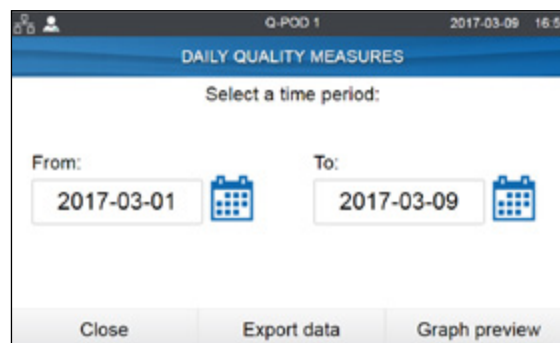

Note: A complete history report with all system activity is available. By default it is only available when logged-in as the system manager. This can be modified by de-activating the system manager profile in the settings menu, go to page 19 [Settings > Manager access](#).

Flow schematic

This is a graphic representation of the hydraulic components of the water purification system. Components change colour depending on the state and system status.

Grey - inactive Blue - active
Yellow - maintenance alert Red - technical issue alarm

Production flow schematic

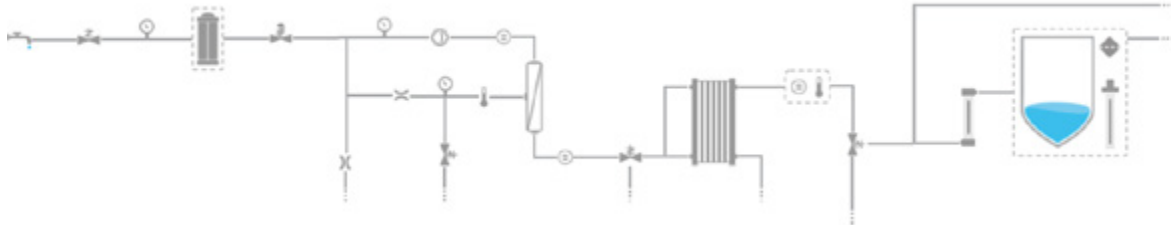

Distribution flow schematic

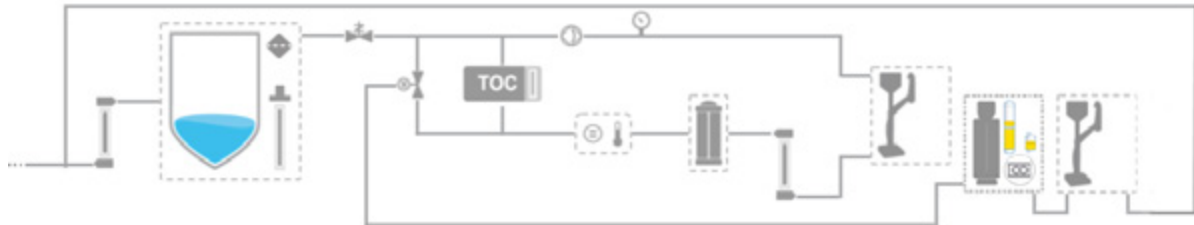

Troubleshooting

Access a diagnostic summary.

This app contains all the necessary information in one location for effective troubleshooting when in contact with the technical support hotline.

- System information & last service visit
- Water quality & consumables (installed dates)
- Active alerts, alarms & auto-test results
- Diagnostics

Contacts

To edit contact information, login as the system manager, go to page 19 [Settings > Manager access](#). The user parameters are used on various reports generated by the system and can quickly help users identify the right contact for any questions or issues.

Technical support hotline	In case of troubleshooting
Application specialist	Application enquiries or quote requirements
Field service engineer	<i>Only in selected countries, contact technical support</i>
System manager	Responsible for system configuration & quality settings
Maintenance operator	Responsible for maintaining the system

SETTINGS MENU









Different settings are available to customize the water purification system operation. Depending on the user profile (end-user operator / system manager) some of the settings will have either read-only or read & write access.

Settings		End-user	System Manager
System Configuration	Screen saver	Read only	✓
	Water sensor	Read only	✓
	Alarm relay	Read only	✓
Production configuration	Periodic EDI rinsing check time	Read only	✓
	Periodic EDI rinsing duration	Read only	Read only
	Periodic EDI rinsing period	Read only	Read only
Tank configuration	Tank capacity	Read only	Read only
	Tank refill setpoint	Read only	✓
	ech2o ASM lamp cycle start hour	Read only	✓
Distribution configuration	Lab close	✓	✓
	Recirculation Duration	Read only	Read only
	Safety flow stop	Read only	✓
	Dispensing Mode	Read only	✓
Production alarm configuration	EDI resistivity	Read only	✓
	Permeate conductivity	Read only	✓
	RO ionic rejection	Read only	✓
	RO feed conductivity RO high	Read only	✓
	RO feed conductivity tap high	Read only	✓
	Inlet strainer clean	Read only	✓
	Cl2 clean	Read only	✓
	IPAK Gard lifetime		✓
	IPAK Gard volume		✓
Tank alarm configuration	Vent Filter		✓
	Tank empty	Read only	✓

Settings		End-user	System Manager
Distribution alarm configuration	Product resistivity	✓	✓
	Product TOC	✓	✓
	IPAK Quanta		✓
	Millipak		✓
	Millipak Gold		✓
	LC-Pak		✓
	VOC-Pak		✓
	EDS-Pak		✓
	LC-Pak 0.1µm		✓
	0.1µm-Pak		✓
Connectivity	Local network	Read only	✓
Date, Time & Language	Time zone - Date - Time	Read only	✓
	Select language	Read only	✓
Password	System manager		✓
Units	Resistivity / Conductivity	Read only	✓
	Temperature	Read only	✓
	Storage tank	Read only	✓
	Temperature compensation mode	Read only	✓
	Pressure	Read only	✓

Available apps:

 System Configuration	 POD Configuration	 Date, Time & Language	 Password
 Alarm Configuration	 Connectivity	 Units	

Note: Dispensing while in this menu is not available.

Manager access & password

Login as a Manager

1. Press on the menu button  from the Home page.

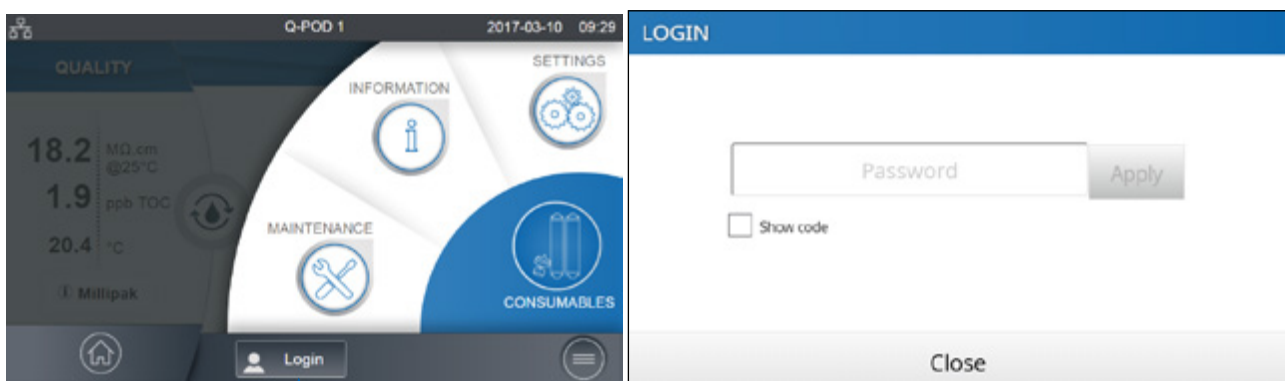

2. Press on Login:.....
3. Enter system manager password.

To display & see the password while typing, check the Show code box Show code

Once logged-in, the manager icon  is displayed in the top left corner.

If a manual logout is not performed, the system manager profile will be automatically logged off after 1 hour.

Note: By default this parameter is activated. The default password is **PASS**
If the system manager password is forgotten, contact the technical support hotline.

Log off as a Manager

1. Press on the menu button .
2. Press on "Logout".

Modify system manager settings

This can only be done when logged-in as a manager.
In the **Password** app:

1. Deactivate/re-activate the manager password through the password activation slider button.
2. If required, change the password.

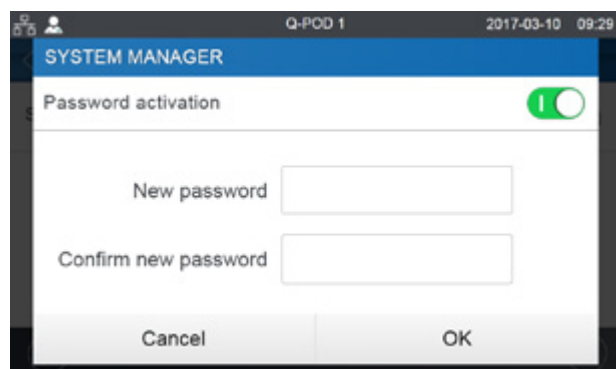

Important! Deactivating the system manager profile will enable all settings to be modifiable by any user.

System configuration

Lab close

When leaving the lab for long periods of inactivity, this mode can be activated to save energy and reduce wear of system components. Recirculation is reduced to once a day. 24h prior to resuming lab activity, the system automatically resumes a recirculation every hour, ensuring it is ready for use.

1. Activate Lab close via the slider button.
2. Enter a Start and End date (minimum of 3 days). Lab close mode will be initiated at 00:01 on the selected date.

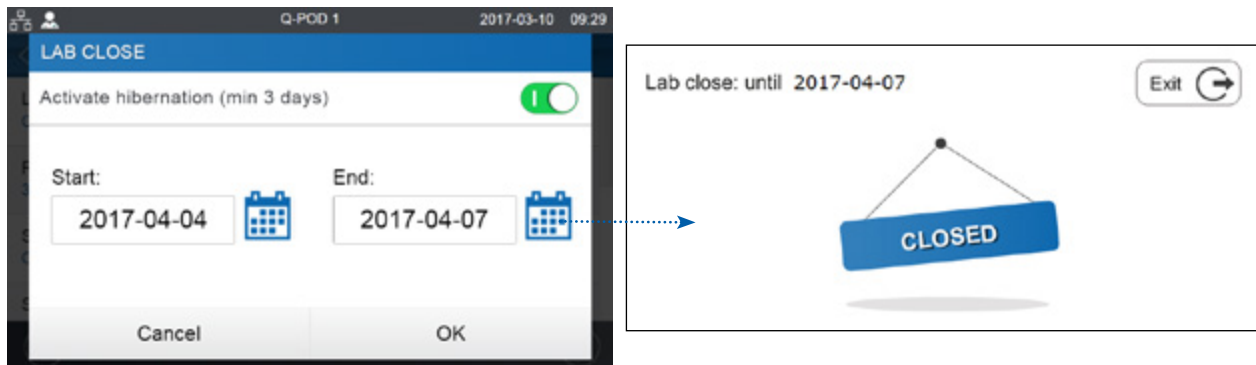

Safety flow stop

A precautionary measure that stops a POD dispensing after having continuously delivered water for a certain duration.

Adjust to the preferred time by using the arrows or click on the box to access the keypad.

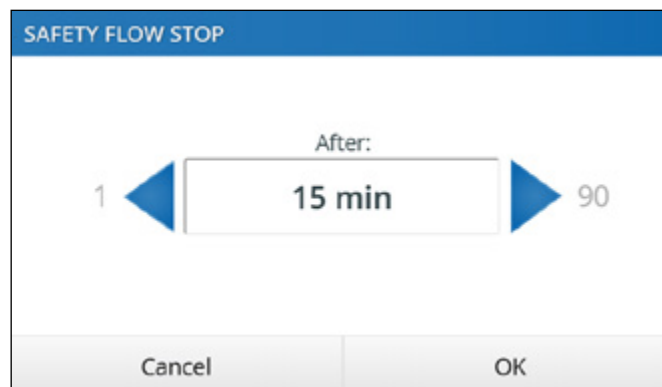

This setting will not impact volumetric dispensing functions.

Screensaver

This is the maximum duration of inactivity on a POD before the screensaver starts.

1. Activate / deactivate via the slider button.
2. Adjust to the preferred time by using the arrows or click on the box to access the keypad.

This setting applies to all connected PODs. By default the screensaver is active and the timer is set to 5 minutes.

Production configuration

The system includes a periodic EDI rinsing feature to ensure a good system performance and water quality is always maintained.

The rinsing will take place at the time of the day set in *Periodic EDI rinsing check time*, that can be chosen by the system manager to better adapt to the work time schedule.

The system will rinse the EDI for the *Periodic EDI rinsing duration* (1h by default) whenever the system did not produce Elix water for at least 1 hour during the time period set in the *Periodic EDI rinsing period* (24h by default).

POD configuration

This app allows a user to configure all parameters specific to PODs. These are unique to the POD that is being used to input the values.

To duplicate POD parameters, the action(s) should be repeated on all other PODs.

POD Name

This can be personalized. Click on the text box and input up to a maximum of 8 characters.

Screen brightness

Adjust to the preferred brightness from 1 to 7 using the arrows or click on the box to access the keypad and type-in the value.

Sound volume

Each POD can emit a sound when alerts/alarms are triggered. This can be activated or deactivated using the slider button. The sound can be adjusted to the desired volume by using the arrows or click on the box to access the keypad and type-in the value. By default, the sound is deactivated.

Flowmeter offset

The flowmeter has been calibrated in order to achieve volume precision of +/- 2% for Q-POD and +/- 5% for E-POD. Laboratory glassware accuracy can vary a lot. This setting provides a user with the ability to adapt the flowmeter to their current glassware accuracy by using an offset function.

Adjust the offset by using the arrows or click on the box to access the keypad and type in the value. To gain back the original calibration settings, set the value back to 0.

Accessories

Water sensor

A water sensor can be connected to the system unit to stop the system from producing water in case of water spillage. Up to 3 sensors can be connected in series to cover a wider surface area.



Foot pedal

The pedal is connected to the base of the Q-POD. In the Q-POD configuration app, activate the foot pedal via the slider button.

Dispense using the foot pedal

1. Press once and release to dispense in full flow.
2. Press and hold to start dispensing in drop-by-drop, keep pressing to increase the flow rate up until full flow is reached. Release at the chosen flow rate.
3. Press once to stop the flow dispensing.



Washer Distribution kit

This accessory will allow distributing water from a storage tank to washing machines.

Note : specific tank vent filter HF used for high flowrate application.



Alarm relay

This accessory will allow to relay all, or a selection of alarms to a remote device.

Select the alarm(s) that will activate the relay.

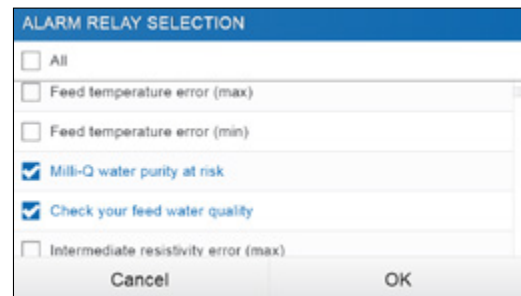

Sanitary Sampling valve for storage tank

The unique design of the sanitary sampling valve allows the user to sample mid-stream and prevents accumulation of bacteria or particles inside the sampling probe.

It can also be sanitized effectively and easily in place.



Alarm configuration

Adjust the alarm set points by either clicking on the arrows or alternatively, click in the box to access the keypad and directly type-in the value.

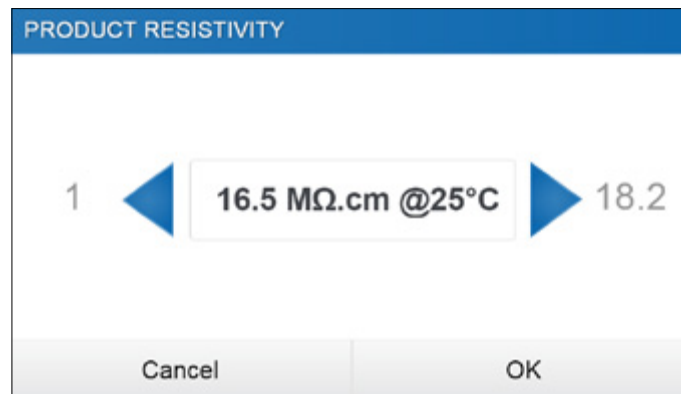

Water quality

- Product resistivity/conductivity
- Product TOC

Inlet strainer clean

It is recommended to clean the inlet strainer once a year to avoid it becoming clogged. Depending on the feed water and its particle concentration, the inlet strainer clean frequency can be adapted.

Cartridge lifetimes

Cartridges should be changed when the system alerts the user.

Saturated pack content will start to let ion and organic contaminants through. This is called breakthrough and often starts with traces that cannot be detected by on-board monitoring. Some technologies will clog, creating a back pressure which can result in flowrate issues or pressure alarms in the system.

In validated settings, to adjust lifetimes according to existing SOPs, click on the applicable filters and adjust accordingly.

Connectivity

The system offers the possibility to be connected to a laptop with a fixed IP address or to your local network (DHCP protocol/fixed IP address) via an Ethernet port. The DHCP (Dynamic Host Configuration Protocol) is an “automatic configuration” of a device anytime it connects to an IP Network. This “automatic configuration” is called allocation. The system is automatically recognized and configured so that the networks resources can be used. Check with your local IT resources which type of connection is best suited to you.

Change network connection settings

1. For a direct connection, change the network settings if necessary (default IP address: 192.168.1.69).
2. For network connection, activate DHCP via the DHCP activation button.

Duplicate user interface in a browser

Once connected:

1. Go to your browser. For best browsing performance, Chrome® is recommended.
2. Enter the IP address of your system which can be found in the connectivity pop-up screen.

Note: The view from a laptop enables a user to view the Q-POD display remotely. Dispensing operations cannot be conducted remotely for safety reasons.

Date Time & Language

The norm ISO® 8601 has been used as a reference for a standardized way of presenting dates and times.

Date

Calendar date representations are shown in the form “2018-11-06” [YYYY-MM-DD]. [YYYY] indicates a four-digit year. [MM] indicates a two-digit month of the year, 01 through 12. [DD] indicates a two-digit day of that month, 01 through 31.

Start by setting the year:

1. Click on the *month & year* title, this displays months and only the year as a title. Click again on the *year* title to display years.
2. Select the year, this then displays months.
3. Select the month, this then displays the days.
4. Finally select the day to confirm the date setting.

Time ZONE

1. Select the continental or oceanic zone you are in on the left. This updates the right-hand side with all the major cities within this time zone.
2. Select the appropriate city. If you have not found a city, make sure you are in the right time zone.

The Milli-Q® system is now configured to display current local time and automatically updates when daylight saving time applies.

Time

The time is set and displayed in a 24h clock format. A time of day is written in the 24-hour notation in the form hh:mm (for example 14:23), where hh (00 to 23) is the number of full hours that have passed since midnight, mm (00 to 59) is the number of full minutes that have passed since the last full hour.

Language

There are 9 languages available: Chinese / English / French / German / Italian / Spanish / Portuguese / Japanese / Russian

Units

Units can be formatted to local needs:

Resistivity / Conductivity	MΩ.cm	μS/cm
Temperature	°C	°F
Storage tank level	L	%
Pressure	Bar / kPa / psi	

Select and press on the unit of interest. The selected unit will appear in blue. Press "OK" to confirm selection and exit the pop-up.

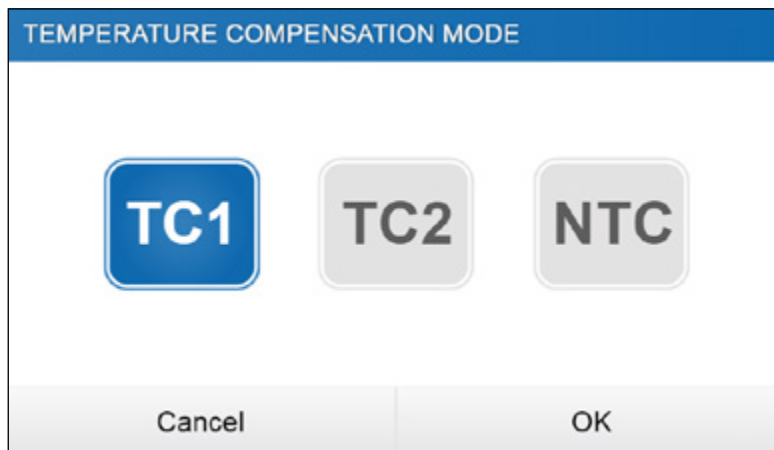

Temperature compensation mode

It is possible to show non-temperature compensated resistivity or non-temperature compensated conductivity. Temperature compensation is a way of standardizing resistivity or conductivity to measurements that would be seen if the water temperature was 25°C.

Select the preferred mode among the 3 modes of temperature compensation available that applies both for pure and ultrapure water:



TC1	<p>By default TC1 mode is selected.</p> <p>The resistivity or conductivity values are temperature compensated to 25°C. The values are normalised. The system firmware eliminates small fluctuations of temperature compensated resistivity or conductivity due to the fact that these two parameters are not measured exactly at the same time.</p>
TC2	<p>The actual temperature compensated resistivity or conductivity values are displayed. The TC2 setting should be used in applications that require the detection of trace ionic levels or when performing the verification of the system resistivity meter operation with an independent calibrated resistivity meter. In some operating conditions the feed water can be warmer or cooler than the water temperature inside the system. As a result, this can cause small fluctuations of the resistivity and conductivity values. Resistivity values could fluctuate for ultrapure water between <i>18.0 MΩ.cm and 18.4 MΩ.cm @25°C</i> while the actual resistivity is <i>18.2 MΩ.cm @25°C</i>. Resistivity values could fluctuate for pure water between <i>14.8 MΩ.cm and 15.2 Mohms.cm @25°C</i> while the actual resistivity is <i>15 MΩ.cm @25°C</i>.</p>
NTC	<p>Non Temperature Compensation. The temperature compensation is off. The displayed resistivity or conductivity is not temperature compensated. The temperature of the water is shown at the same time as the non-temperature compensated resistivity or conductivity value.</p>

MAINTENANCE MENU



The maintenance of the system is easy thanks to the step-by-step instructions contained in the wizards. In addition, a new cartridge design means that pack removal and installation in the system unit is quick and effortless.

Available apps:

 Install consumables	 Care/cleaning
 Depressurization	

Note: Dispensing in this menu is only available in the applicable wizards.

Maintenance screens

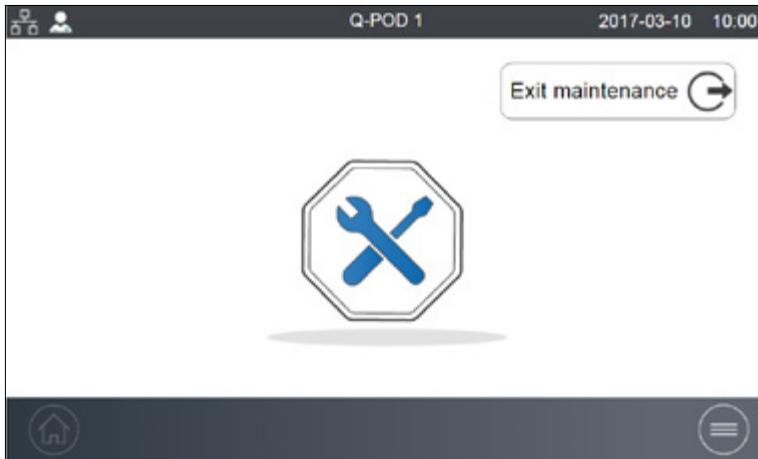

Maintenance ongoing from the current facing POD.

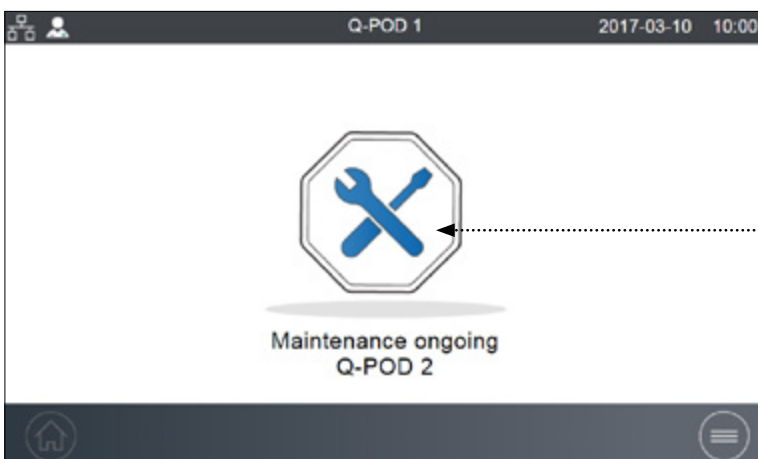

Note: To unlock all PODs from maintenance mode and regain access to dispensing functions, click on "Exit maintenance".



Maintenance ongoing from another POD or from a remote location if "External" is indicated on the screen.

Consumable installation wizards

A maintenance wizard can be accessed in different ways:

1. Through the Maintenance menu 
2. A shortcut from an Alert  or Alarm  pop-up
3. A shortcut from a consumable pop-up

IPAK Gard and IPAK Quanta replacement

1. Select **Install consumables** app and click on *IPAK Quanta installation*.
2. Follow the self-guided wizard.

IPAK® Gard® 3-5 pretreatment pack : IPAKGARA1
IPAK® Gard® 10-15 pretreatment pack : IPAKGARA2
IPAK® Quanta® polishing cartridge : IPAKQUAA1

1 or 2 IPAK® Gard® depending on system type

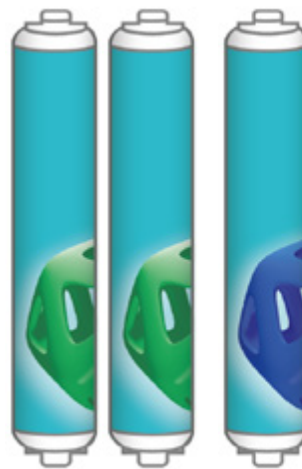

Note 1: For IPAK Quanta before starting the rinse, ensure there is at least 30L of water present. If the IPAK Quanta rinse runs out of water, it stops the rinsing but automatically starts again when water returns. It restarts where it was interrupted.

Note 2: When properly installed, the blue side should face you with the **e-Sure**  symbol behind.

Note 3: If the sound has been activated, it is normal to hear a buzzer when changing the consumables. This is temporary and is only present when the IPAK or POD-Paks are removed. As soon as they are put back into place, the buzzer will stop.

For pack removal, press on the button, rotate and pull. For pack installation twist until the click as described in the self guided wizard.

Pack Replacement

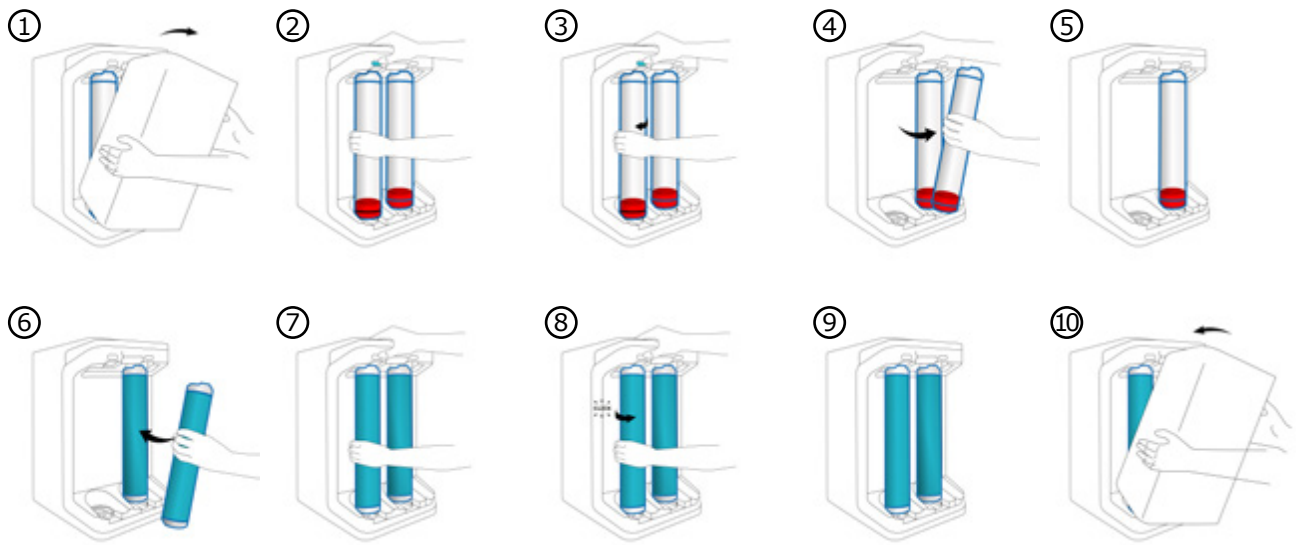

Note : The Milli-Q IQ 7010/7015 systems have 3 packs (2 IPAK Gard + 1 IPAK Quanta) whereas the Milli-Q IQ 7003/7005 systems have 2 packs (1 IPAK Gard + 1 IPAK Quanta).

Application POD-Pak installation

1. Select **Install consumables** app and click on *Install application POD-Pak*.
2. Select the POD-Pak to be installed, click on the *Next* button and follow the self-guided wizard.



Do not over tighten the twist & lock action when installing a new POD-Pak.

3. Rinsing must be performed manually to complete the installation as indicated on the screen. When completed press "Finish" to exit the wizard.

Note: All certificates of quality are now available online.

Visit www.mymilliqconsumables.com

Storage tank vent filter replacement

The vent filter located at the top of the storage tank can easily be removed and replaced as described below.

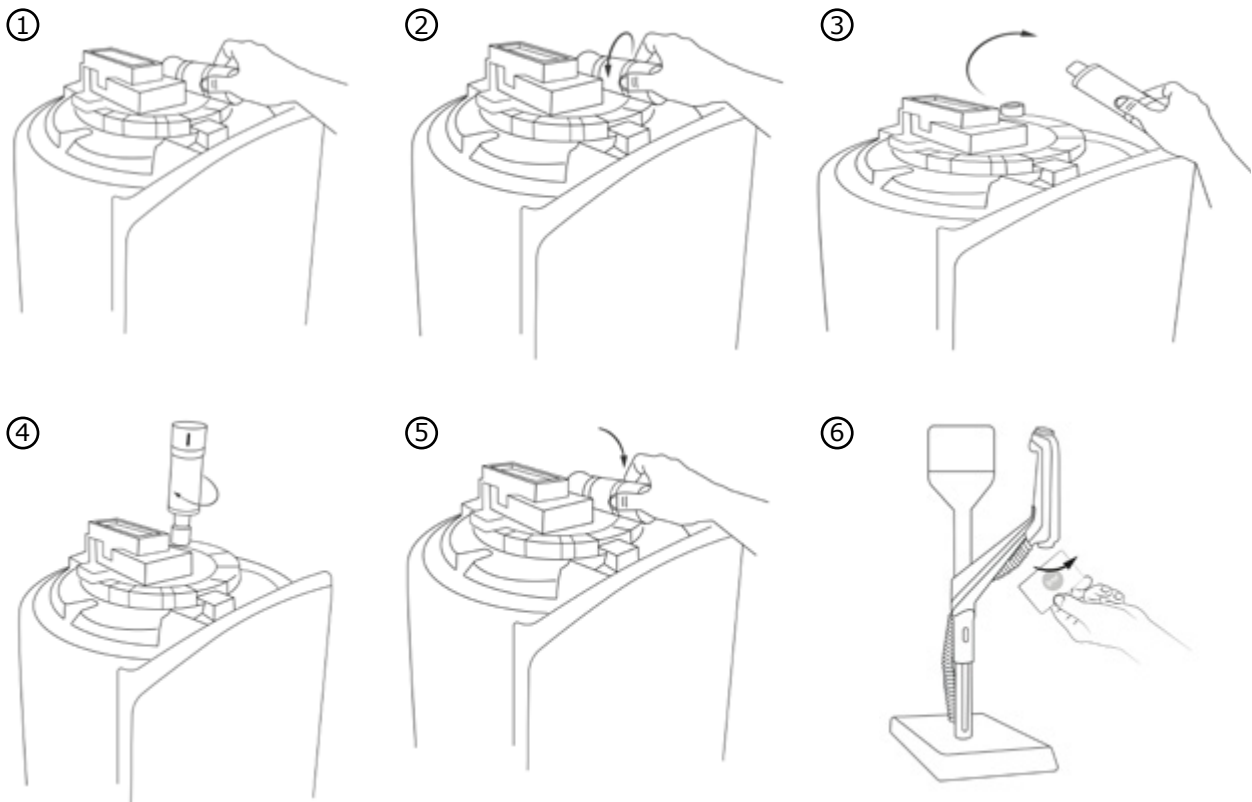

Important! The tank lid should remain locked. Never try to lift it due to the presence of the ASM UVc LED.

Milli-Q IQ Element consumables replacement

Follow the self-guided wizard.

1 : Remove old Optimizer

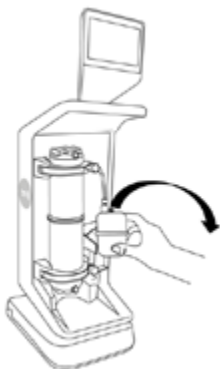

2 : Install the bypass

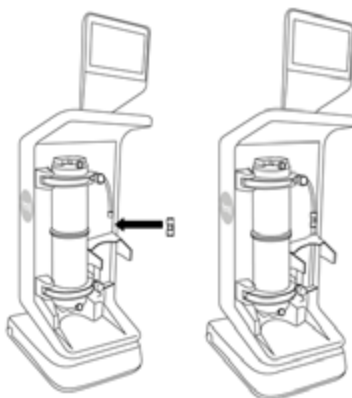

3 : Remove old Quanta® ICP®

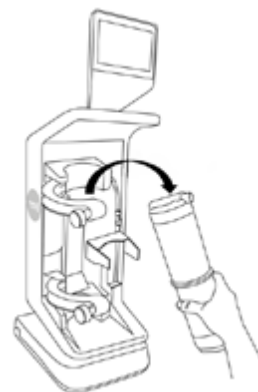

4 : Install new Quanta ICP

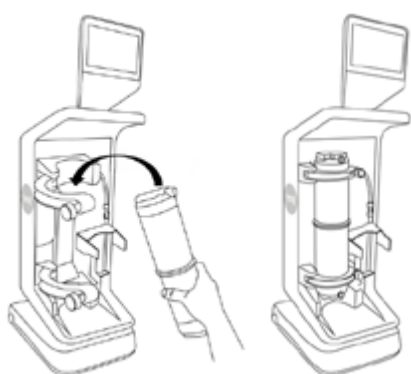

5 : Start rinsing



6 : Remove the bypass when rinsing is complete

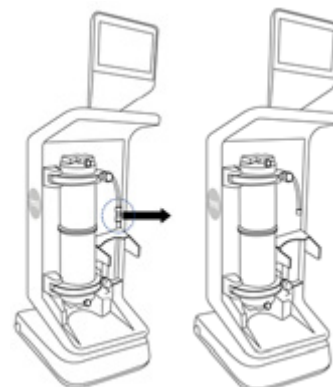

7 : Install new Optimizer

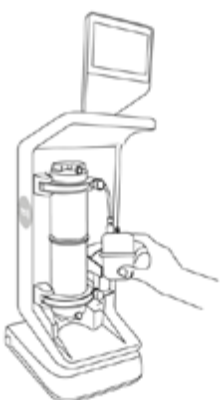

8 : Run 20L volumetric dispensing

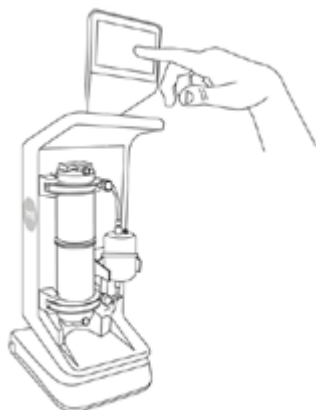

9 : Air purge the Optimizer



10 : put back front cover



Cleaning & Sanitization

Cleaning the inlet strainer

The purpose of the inlet strainer is to prevent large particles from entering the Milli-Q system. If the inlet strainer becomes clogged, then feed water does not flow freely to the system.

Select **Care/Cleaning** app and click on *Inlet strainer clean*. Follow the self-guided wizards.

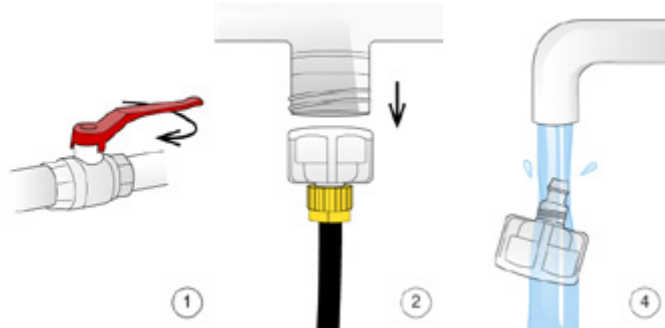

Cleaning the A10 TOC Monitor

This is recommended when:

- A new IPAK Quanta cartridge (and IPAK Quanta ICP if applicable) is installed
- TOC values are fluctuating
- TOC values are higher than normally seen

Select **Care/Cleaning** app and click on *A10 monitor clean*. For best results, an A10 clean should be performed for its full duration (60 minutes). If necessary, repeat the procedure.

CI2 Cleaning

Follow the self guided wizard. Contact your service representative for further information.

PH Cleaning

Follow the self guided wizard. Contact your service representative for further information.

Depressurization

This temporarily stops production and all water processes.

This function is not necessary during normal system operation. See self help guide section.

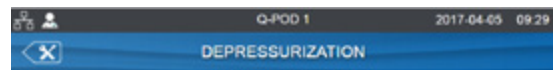

Place the Q-POD near a sink and press the dispenser wheel to depressurize the system.

ech₂o UV lamps - mercury free

Contact the technical support hotline to organize a replacement visit.

It is highly recommended to have a qualified Milli-Q field service representative to change the ech₂o UV lamps. Replacement of the lamps involves removing the panels of the Milli-Q system.



Hazardous voltage!

Hazard of electrical arc flash will cause death or serious injury.

Important! Never open the system, even when the power switch has been switched off.

It is not sufficient to switch off the system, the plug must be physically removed from its power source. Installation and maintenance should only be done by a qualified person. Appropriate personal protective equipment (PPE) must be worn and safe work practices must be followed.

SELF HELP GUIDE

Depressurize system

Depressurize both the Production and Distribution sections of the system in case of water leak to temporarily stop production and all water processes. Go to page 32 [Maintenance > Depressurization](#).

Identify the source of the leak. Once fixed, to exit this mode, a user will need to go back to the home screen on which the initial depressurization took place and select *Exit button* on the drop-down screen for dispensing to become available again on all Q-PODs.

Turn system off

Press the ON/OFF switch located on the left side of the unit.

Note: When the system is on, the power switch is lit.

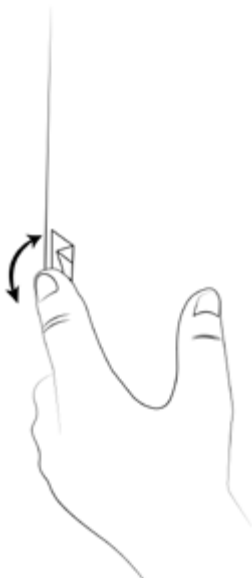

& **UNPLUG**

Important! Never open the system, even when the power switch has been switched off. Hazardous voltage is present with a hazard of electrical arc flash. Will cause death or serious injury.

It is not sufficient to stop all power to system, the plug must be physically removed from its power source. Installation and maintenance should only be done by a qualified person. Appropriate personal protective equipment (PPE) must be worn and safe work practices must be followed.

If the system is powered off for 20 days, the capacitor will completely discharge. When powering on again the system, the time & date settings will need to be reset, see page 24 [Information>Date Time & Language](#). It takes about 45 minutes to recharge the capacitor.

Inaccurate volumetric dispensing

Volumetric dispensing has been validated to work with a +/- 2% precision for Q-POD and +/- 5% precision for E-POD. Lab glassware precision can vary and to accommodate local needs a flow meter offset menu has been created. Go to page 21 [Settings>Flow meter offset](#) for more information.

High TOC values

TOC levels can vary depending on the type of feed water or the laboratory environment. Here are a few recommendations to follow:

1. A pack replacement can temporarily increase the TOC until they have been completely rinsed out.
2. Clean the A10 TOC Monitor cell, go to page 31 [Maintenance>A10 Cleaning](#)

Low flowrate

- Ensure the POD-Pak is not air-locked. This can happen in the weeks that follow a replacement of IPAK cartridges. Dispense water and open the POD-Pak air vent to see if there is any trapped air. Close the vent once the air has been released.
- One possible reason for a decrease in Milli-Q Water flowrate is a clogged POD-Pak. The POD-Pak should be replaced when it appears to be clogged.

Tank is not re-filled of pure water

- Open the drop down menu swiping down on the touchscreen to check the status of the pure production section.

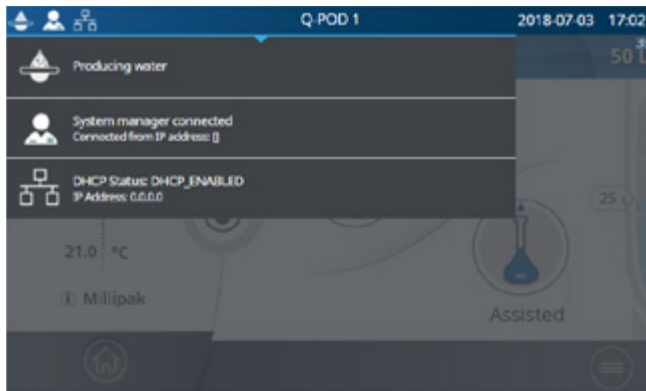

- Exit the maintenance or rinsing mode in case it is activated.

























- Solve any alarms that could be stopping the production process.



Contact US

Get in contact with the local technical support hotline. The details can be found in the contacts app, go to page 14 [Information >Contacts](#) or visit our website www.emdmillipore.com (North America) or www.merckmillipore.com (Rest of the World).

ICONS

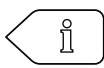
Icon	Meaning/Function	Icon	Meaning/Function
	Recirculation		Dispensing
	Volumetric dispensing		Assisted dispensing
	Start dispense		Stop dispense
	Alarm with number of active alarm(s)		Alert
	Home		Menu
	Storage tank		System manager logged in
	Mass storage USB connected		Ethernet - LAN status connected
	Slider ON		Slider OFF
	Back		Calendar entry
	Production Unit producing water		Production Unit standby
	Production Unit blocked		Production Unit maintenance
	Production Unit Maintenance exit		Back to main menu

REQUIREMENTS AND SPECIFICATIONS

Water specifications

Elix Water

The system has been designed to produce water according to specifications when operating within feed water requirements.

Parameter	Value or range
Resistivity	> 5 MΩ.cm @ 25°C
Conductivity	< 0.2 μS/cm @ 25°C
Total Organic Carbon (TOC)	≤ 30 ppb
Particles (size > 0.22μm)	No particles with size > 0,22 μm if 0,22μm filter used
Bacteria	< 0,01 CFU/mL (with Millipak® 40 or Biopak® filters when installed and used in a laminar flow hood)
Pyrogens (endotoxins)	< 0,001 EU/mL (with Biopak® filter when installed and used in a laminar flow hood)
RNases	< 1 pg/mL (with Biopak® filter)
DNases	< 5 pg/mL (with Biopak® filter)
Proteases	< 0.15 μg/mL
Flow rate	3 L/h for IQ 7003 5 L/h for IQ 7005 10 L/h for IQ 7010 15 L/h for IQ 7015

The Milli-Q IQ 7003/7005/7010/7015 system is intended to produce ultrapure water that meets or exceeds requirements as described by the organizations below:

Organization	Water quality / grade
European Pharmacopeia	Purified water
U.S. Pharmacopeia	Purified Water
Japanese Pharmacopeia	Purified Water
Chinese Pharmacopeia	Purified Water
ASTM® D1193	Type II water Grade B
ISO® 3696	Grade 2 water
Chinese National Standard	GB 6682 Grade 2 water
JIS K 0557	A2 water

REQUIREMENTS AND SPECIFICATIONS

Water specifications

Product Water

The system has been designed to produce water according to specifications when operating within feed water requirements.

Parameter	Value or range
Resistivity	18.2 MΩ.cm @ 25°C
Conductivity	0.055 μS/cm @ 25°C
Total Organic Carbon (TOC)	≤ 5 ppb
Particles (size > 0.22μm)	No particles with size > 0,22 μm if 0,22μm filter used
Bacteria	< 0,01 CFU/mL (with Millipak® 40 or Biopak® filters when installed and used in a laminar flow hood)
Pyrogens (endotoxins)	< 0,001 EU/mL (with Biopak® filter when installed and used in a laminar flow hood)
RNases	< 1 pg/mL (with Biopak® filter)
DNases	< 5 pg/mL (with Biopak® filter)
Proteases	< 0.15 μg/mL
Flow rate	up to 2 L/min
Volumetric Dispensing Accuracy	+/- 2% for QPOD ; +/- 5% for EPOD

The Milli-Q IQ 7003/7005/7010/7015 system is intended to produce ultrapure water that meets or exceeds requirements as described by the organizations below:

Organization	Water quality / grade
European Pharmacopeia	Highly purified water
U.S. Pharmacopeia	Purified Water
Japanese Pharmacopeia	Purified Water
Chinese Pharmacopeia	Purified Water
ASTM® D1193	Type I water grade B
ISO® 3696	Grade 1 water
Chinese National Standard	GB 6682 Grade 1 water
JIS K 0557	A4 water
Clinical and Laboratory Standards Institute (CLSI®)	Clinical Laboratory Reagent Water (CLRW)

Milli-Q IQ Element water quality

Parameter	Value or range
Resistivity	18.2 MΩ.cm @ 25°C
Total Organic Carbon (TOC)	≤ 5 ppb
Particulates > 0.1 μm	<1 particulates/mL
Bacteria	<1 cfu/mL
Flow rate	up to 2 L/min

Note :

These specifications are valid for a Milli-Q IQ Element Unit fed by water produced by a Milli-Q® IQ 7003/7005/7010/7015 System with resistivity at 18.2 MΩ.cm and TOC < 5 ppb. Some specifications may only be achieved after start-up and only if the system has been rinsed correctly.

Feed Water

The system has been designed to operate within feed water requirements:

Parameter	Value or range
Pressure	1 bar < P < 6 bar
Type of water	Potable tap water
Temperature	5 - 35°C (41 - 95°F)
Conductivity	< 2000 µS/cm @ 25° C
Dissolved CO ₂	< 30 ppm
Free Chlorine	< 3ppm
Fouling Index	< 10
pH	4 < pH < 10
Maximum Total Organic Carbon (TOC)	< 2 ppm
LSI	< 0.3
Hardness as CaCO ₃	< 300 ppm
Silica	< 30 ppm

System specifications

Electrical

The power supply converts mains voltage to 28 V. The power supply is compatible worldwide.

Catalog	Frequency	Max power	Voltage
ZIQ7003T0	50-60 Hz \pm 10%	600 VA	100 – 240 V \pm 10%
ZIQ7005T0	50-60 Hz \pm 10%	600 VA	100 – 240 V \pm 10%
ZIQ7010T0	50-60 Hz \pm 10%	600 VA	100 – 240 V \pm 10%
ZIQ7015T0	50-60 Hz \pm 10%	600 VA	100 – 240 V \pm 10%

Environmental

Specific environmental conditions have to be respected to ensure normal operation of the Milli-Q system.

Location	indoor use only
Ambient operating temperature	room temperature ranges from 4°C to 40°C
Relative humidity	room relative humidity conditions of 80% for a temperature up to 31°C, decreasing linearly to a relative humidity of 50% at 40°C
Altitude	up to 3000m above sea level
Installation category	bench / underbench or wall mounted
Pollution degree	2
Noise level	< 50 dB at 1m

Communication

Each POD has a large HD capacitive 5" touch screen (Resolution: 800*480) that allows control and monitoring of the system.

USB

The POD has a built-in USB port that offers the possibility to download the water system user manual or to export the system data and/or history. The Host interface is compliant with the USB 2.0 High-speed standard.

USB keys only work when formatted FAT32. NTFS format is not compatible.

Ethernet

When connected through an Ethernet protocol, the display interface can be accessed remotely using internet web browsers.

For best browsing performance, the recommended browser is Chrome®.

RFID (case with embedded radio feature)

Use only the built-in antenna supplied. Unauthorized modification of the antenna or use of unauthorized accessories might damage the system and render it non-compliant with the EU RED directive and/or FCC regulations.
Standard

EU

We certify that these Lab Water Systems are designed and manufactured in application of the following European Council directives:

DIRECTIVE 2014/53/EU OF THE EUROPEAN PARLIAMENT AND OF THE COUNCIL of 16 April 2014 on the harmonisation of the laws of the Member States relating to the making available on the market of radio equipment and repealing Directive 1999/5/EC.

Standards to which conformity is declared as applicable are the following.

Electromagnetic compatibility and Radio spectrum Matters(ERM) tests according to standards: ETSI EN 300 330.

FCC

FCC part 15: 2014 Code of federal regulations.

Title 47 – Telecommunication chapter 1- Federal Communication Commission.

Part 15- Radio frequency devices Sub-part C- Intentional Radiators Limits and Methods of measurement of radio disturbance.

System software

System software included in this product contains copyrighted software that is licensed under the GNU GPL.

The legal notices are available in the Q-POD display: Information menu > System app > Legal Notices.

Dimensions and weights

Water purification unit (7003/7005)

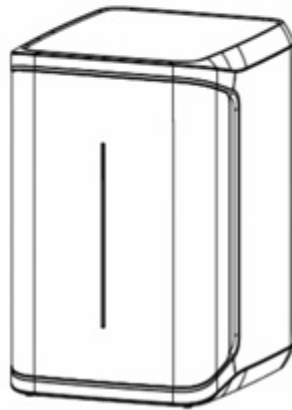
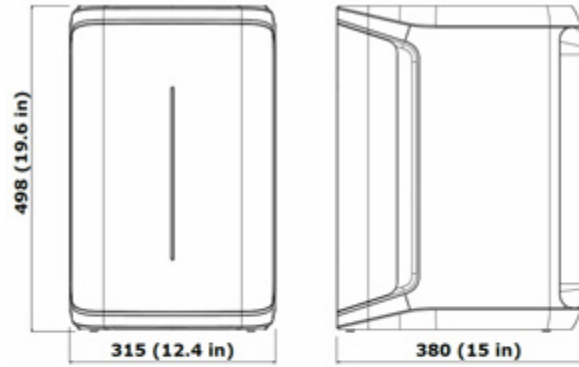

Water purification unit (7010/7015)

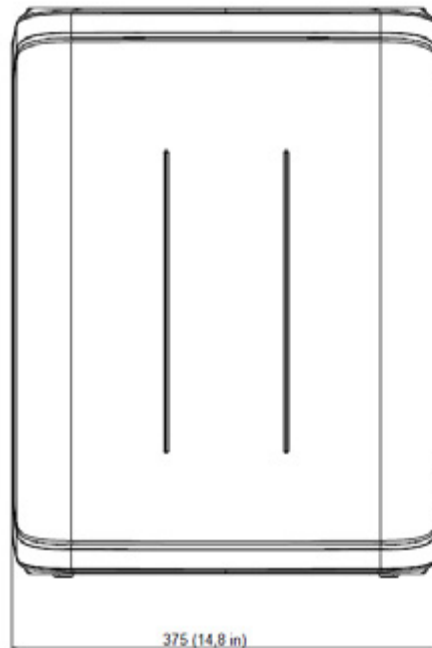
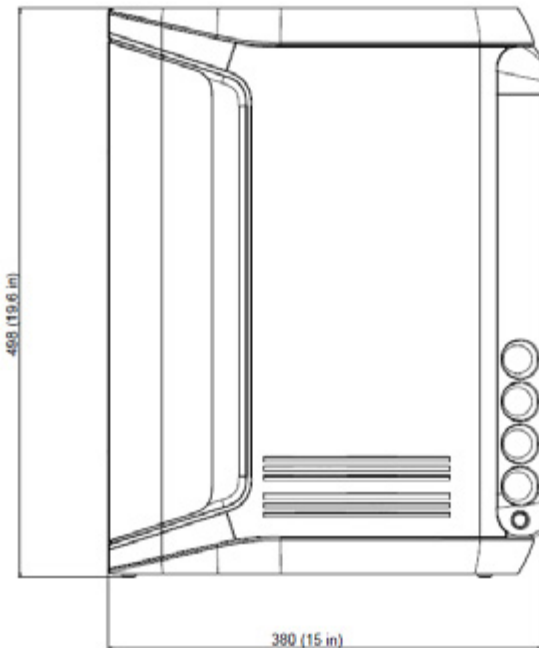

POD

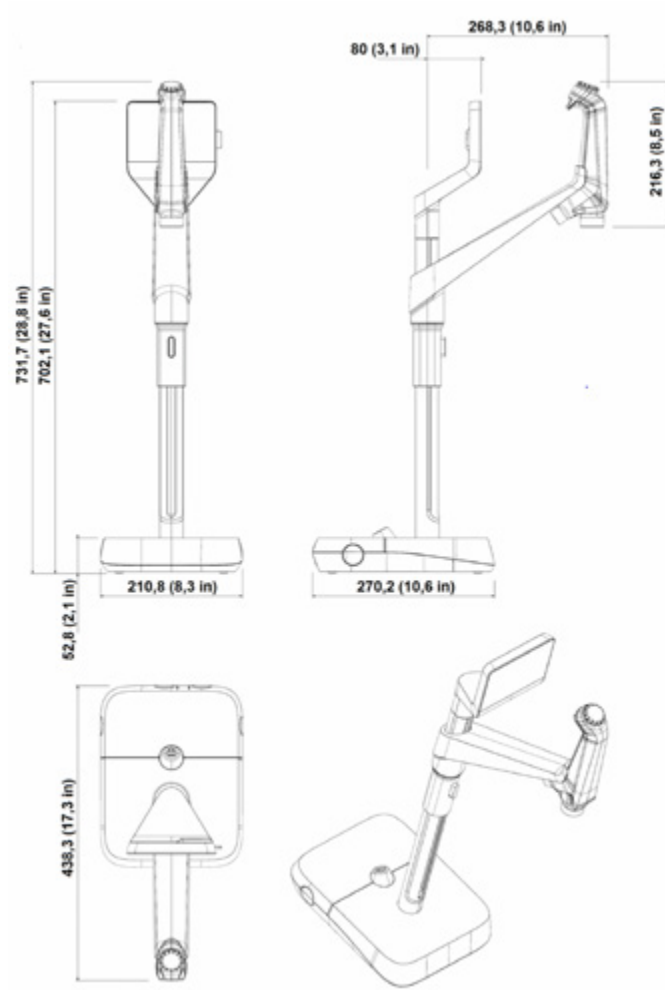

Milli-Q IQ ELEMENT

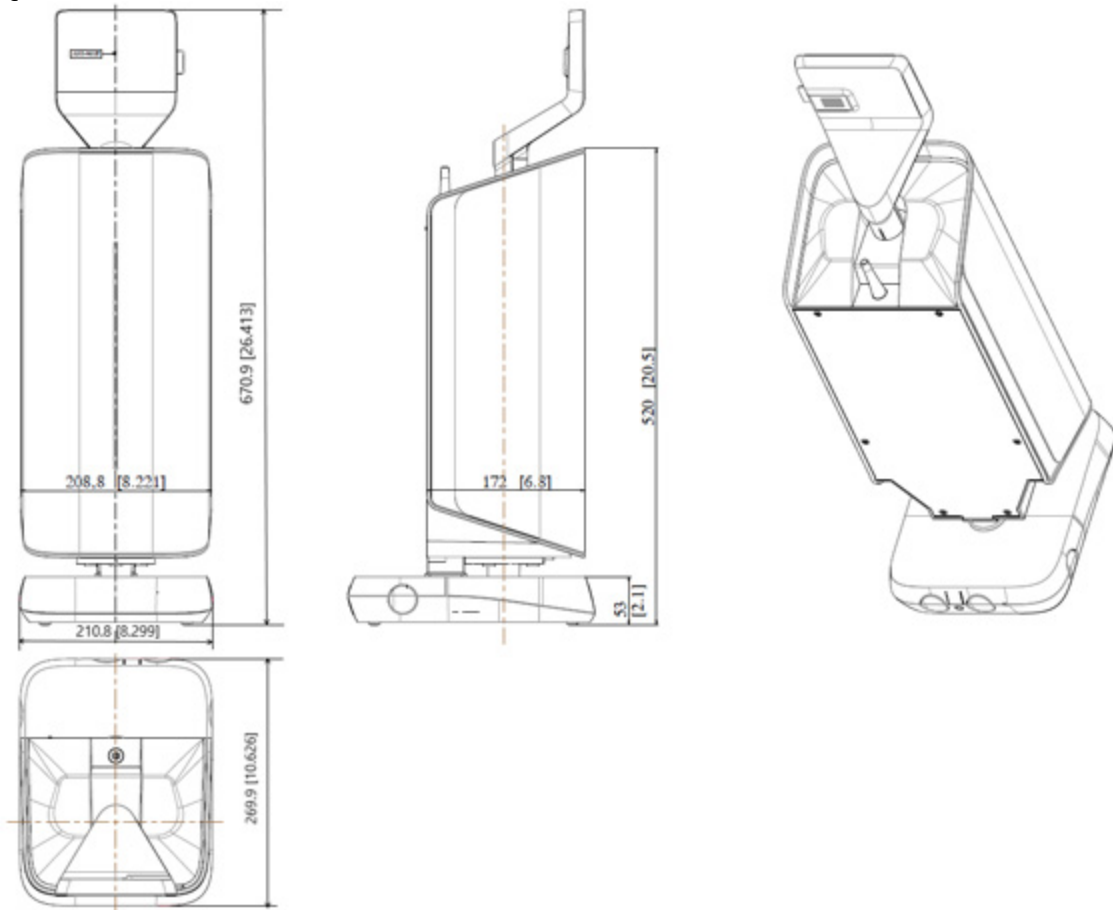

Storage tank 25L - 50 L - 100 L

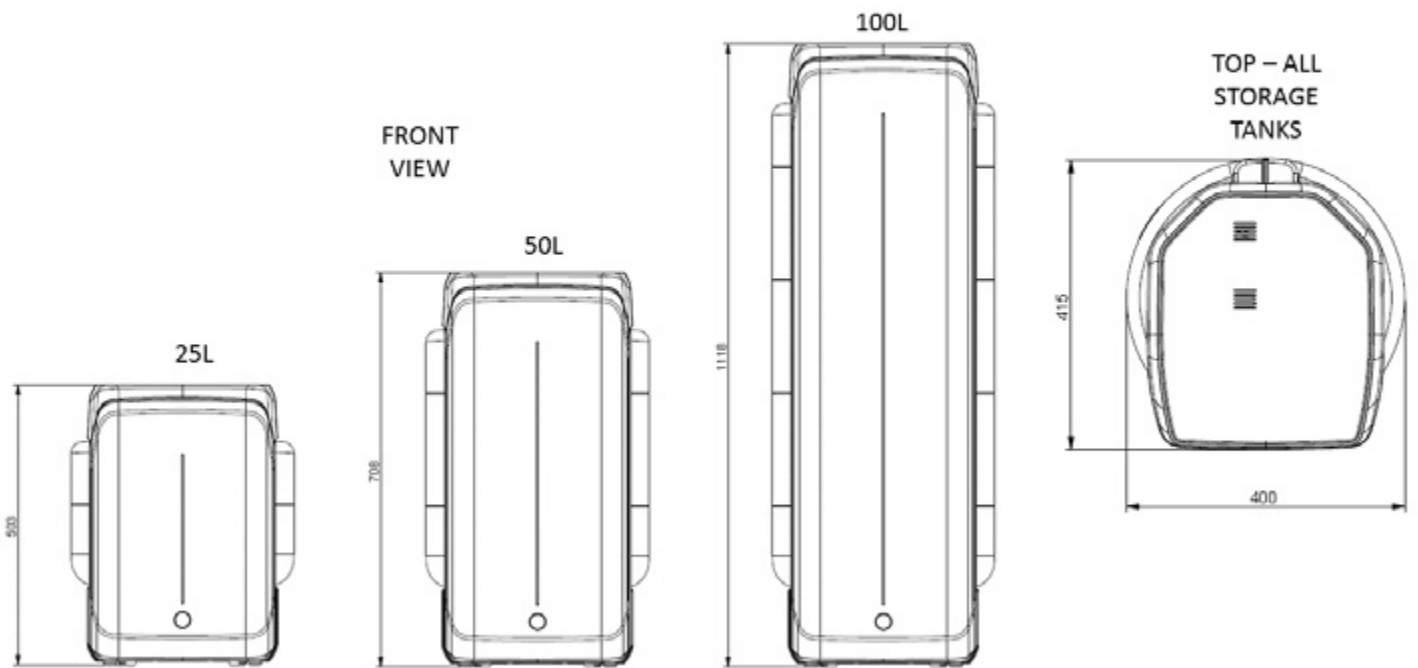

System Type	Dry weight	Shipping weight	Operating weight
Water purification unit (3/5)	21.0 kg (46.3 lb)	24.0 kg (52.9 lb)	26.0 kg (57.3 lb)
Water purification 10	23.7 kg (50.7 lb)	26.9 kg (57.32 lb)	29.7 kg (63.93 lb)
Water purification 15	24 kg (52.91 lb)	27.2 kg (59.52 lb)	30 kg (66.13 lb)
Q-POD/E-POD dispenser	4.7 kg (8.8 lb)	7.2 kg (15.4 lb)	5.5 kg (11 lb)
Milli-Q IQ Element	7.5 kg (15.43 lb)	10.3 kg (22.04 lb)	9.1 kg (19.84 lb)
Water storage 25 L	6.7 kg (13.22 lb)	8.5 kg (17.63 lb)	31.7 kg (68.34 lb)
Water storage 50 L	7.6 kg (15.4 lb)	10.6 kg (22 lb)	57.6 kg (127 lb)
Water storage 100L	10.9 kg (22.04 lb)	12.8 kg (26.45 lb)	110.9 kg (242.5 lb)

Dry Weight is defined as a system without its shipping container. Consumables and accessories are not included.

Shipping Weight is defined as a dry system in its shipping container. Consumables and accessories are not included.

Operating weight is defined as a wetted system with all its consumables, but not any accessories.



Recycling

Directive 2012/19/UE:

For European users only

The symbol "crossed bin" on a product or its packaging indicates that the product should not be treated like household waste when discarded. Instead the product should be disposed of at a location that handles discarded electric or electronic equipment.

Proper disposal of equipment containing electric or electronic components will help to reduce pollution effects to the environment or to human health. Proper recycling of these products helps in environmental preservation and helps to protect natural resources. For more information about recycling of products containing electric or electronic components, please contact your local recycling representative or organization.

ech₂o™ cartridge collection and recycling program

For United States users only

By joining the ech₂o recycle program, cartridges are 100% recycled into lumber products. The program is traceable for reporting convenience and can easily be integrated into your organization's existing waste or recycling plans.

Ordering Information

Accessories

Name	Catalog Number
Connector 2m System-POD	ZFC0NN2SQ
Connector 5m System-POD	ZFC0NN5SQ
Connector 2m POD-POD	ZFC0NN2QQ
Connector 5m POD-POD	ZFC0NN5QQ
Connector 2m System-Tank	ZFC0NN2ST
Connector 5m System-Tank	ZFC0NN5ST
Q-POD Remote Dispenser	ZIQP0D000
E-POD remote dispenser	ZIQEP0D00
Water sensor	ZWATSENA1
Foot pedal	ZMQSFTSA1
System wall mounting bracket	SYSTFIXA1
Tank level adapter	ZSTWIN0A1
e-Sure dispenser tip	ZFDISTPA1
Alarm relay cable	ZMQ0ALCA1
Washer Distribution kit 230V Left	ZWDK5L100
Washer Distribution kit 230V Right	ZWDK5R100
Washer Distribution kit 115V Left	ZWDK6L100
Washer Distribution kit 115V Right	ZWDK6R100
Washer Distribution kit Adaptor	ZWDKADPA1
Washer dist kit wall mounting bracket	WBMWASHA1
System Wall Mounting Bracket	SYSTFIXA1
Wall mounting bracket for storage tank	TANKFIXA1
Tank valve kit	ZFTVK07A1
Sanitary valve kit	ZIQ7ESP01
External solenoid valve	EXTSV00A1
Multi system installation kit	ZIQ7MSKT1
IPAK Quanta for sanitization	IPAKQU0A1
Storage tank frame 25 L	TANKA025
Storage tank frame 50 L	TANKA050
Storage tank frame 100 L	TANKA100
Storage tank top assembly	TANKT0PA1
Milli-Q IQ Element purification system	ZIQELEMTO

Ordering Information

Consumables – order at www.mymilliqconsumables.com

Description	Catalog Number
IPAK Gard 3-5 pretreatment pack	IPAKGARA1
IPAK Gard 10-15 pretreatment pack	IPAKGARA2 (2 cartridges per catalog number)
IPAK Quanta polishing cartridge	IPAKQUAA1
Ech ₂ o ASM Lamp	ASMUVLPA1
Ech ₂ o Bactericidal Lamp	ZIXUVLPA1
Ech ₂ o oxidation lamp	ZIQUVLPA1
Ech ₂ o A10 TOC Lamp	ZFA10UVA1
Millipak 0.22µm filter	MPGP002A1
Millipak Gold 0.22µm sterile filter	MPGPG02A1
Biopak filter	CDUFBI0A1
LC-Pak polisher	LCPAK00A1
LC-Pak 0.1µm polisher	LCPAK01A1
EDS-Pak polisher	EDSPAK0A1
VOC-Pak polisher	V0CPAK0A1
Vent filter HF (for high flow applications)	TANKVH1A1
Vent filter	TANKV01A1
e-Sure dispenser tip	ZFDISTPA1
Prepak filter pretreatment pack	PRPK000A1
MILLI-Q® IQ Element consumable kit	IPAKICPK1

LEGAL INFORMATION & WARRANTY

It has always been Millipore SAS policy to continuously improve its products.

The information in this document is subject to change without notice and should not be construed as a commitment by Millipore SAS. Millipore SAS assumes no responsibility for any errors that might appear in this document. This user manual is believed to be complete and accurate at the time of publication. In no event shall Millipore SAS be liable for incidental or consequential damages in connection with or arising from the use of this user manual.

Product warranty and limitation of liability

The applicable warranty and limitation of liability for the products listed in this publication may be found at www.merckmillipore.com or www.emdmillipore.com within the "Conditions of Sale" applicable to your purchase transaction.

Copyright

© Millipore SAS 2018.

All rights reserved. This document or parts thereof may not be reproduced in any form without the written permission of Millipore SAS.

The photographs illustrating the products are non-contractual.

Trademarks

New trademark names

The initial M, Millipore, Milli-Q, Q-POD, E-POD, Milli-Q IQ Element, A10, ech₂o, IPAK Gard, IPAK Quanta, Millipak, Biopak, EDS-Pak, VOC-Pak and LC-Pak are trademarks of Merck KGaA, Darmstadt, Germany.

Millipore SAS is an affiliate of Merck KGaA, Darmstadt, Germany.

All other trademarks are trademarks of their respective manufacturers.

The Life Science Business of Merck KGaA, Darmstadt, Germany operates as MilliporeSigma in the US and Canada.

Safety information

Your Milli-Q system should be operated according to the instructions in this user manual. In particular, the hydraulic and electrical specifications should be followed and met. It is important to use this equipment as specified in this manual; using this equipment in a different manner may impair the safety precautions of the Milli-Q System.

Never open the system, even when the power switch has been switched off. Hazardous voltage is present with a hazard of electrical arc flash. Will cause death or serious injury. It is not sufficient to stop all power to system, the plug must be physically removed from its power source. Installation and maintenance should only be done by a qualified person. Appropriate personal protective equipment (PPE) must be worn and safe work practices must be followed.







Document Reference: MILLI-Q_IQ_7003/5/10/15_EN_User_Manual

Revision: V2.0

Safety information

Never open the system, even when the power switch has been switched off.

HIGH VOLTAGE INSIDE!

Symbol	What it means
	This UV RADIATION sticker is used to refer to a position on the Water System Cabinet or inside of it where exposure to UV light is possible
	This DANGER sticker is used to refer to a position on the Water System Cabinet or inside of it that could be hazardous.
	This ELECTRICAL GROUND sticker is used to refer to a position on the Water System Cabinet or inside where an electrical ground connection is made.
	This ELECTRICAL DANGER sticker is used to refer to a location on or inside the Milli-Q system where an electrical danger could exist.
	This CAUTION sticker is used to refer to a surface that can be hot. Disconnect and switch power off to allow surface to cool before servicing.
 Hazard	The Milli-Q system must be connected to a source of electrical power that is earth grounded.
 Attention	Before the system is serviced, unplug the electrical power cord. The Milli-Q system must be powered OFF before plugging in or removing any components on the electronic board(s).

The Milli-Q IQ 7003/7005/7010/7015 has been tested by an independent and accredited company for compliance with EU directives related to safety and electromagnetic compatibility. The declaration of conformity is available upon request. The system has been manufactured using components and practices recommended by UL and has been cULus marked. The registration and CB certificates can be verified at www.members.IECCE.org.

In case of wall mounted installation:

For the system Milli-Q IQ 7003/7005/7010/7015 : Use a concrete wall capable of supporting a maximum load of 120 kg. Use 6mm diameter stud and fasteners capable to support a maximum load of 60 Kg each.

For the 25L tank: Use a concrete wall capable of supporting a maximum load of 130 kg. Use 6mm diameter stud and fasteners capable to support a maximum load of 45 Kg each.

For the 50L tank: Use a concrete wall capable of supporting a maximum load of 240 kg. Use 6mm diameter stud and fasteners capable to support a maximum load of 80 Kg each.

For the 100L tank: Use a concrete wall capable of supporting a maximum load of 500 kg. Use 6mm diameter stud and fasteners capable to support a maximum load of 180 Kg each.